Full Plant Deammonification for Energy Neutral Wastewater Treatment

Presenter: Charles Bott, PhD, PE, BCEE
Manager, Chief, Special Projects
DC Water

Presenter: Sudhir Murthy, PhD, PE, BCEE
Manager, Clean Water Quality and Technology
DC Water



The People

Olawale Akintayo

Charles Bott

Ryder Bunce

Kartik Chandran

Michael Desta

Norman Dockett

Haydee De Clippeleir

Dana Fredericks

M. Gomez Brandon

Mofei Han

Martin Hell

Becky Holgate

Rebecca Jimenez

Hansa Keswani

David Kinnear

Yi Wei Ma

Matthew Michaelis

Mark Miller

Sudhir Murthy

Geert Nyhuis

Sylvia Okogi

Ahmed Omari

Maureen O'Shaughnessy

Hong Keun Park

Sabine Podmirseg

Pusker Regmi

Rumana Riffat

Andrew Shaw

Beverley Stinson

Imre Takacs

Claire Welling

Bernhard Wett

- High Rate, CEPT or A-Stage:
 - 55-75% COD removal
- B-stage: 10 - 15 days SRT
 - Deammonification

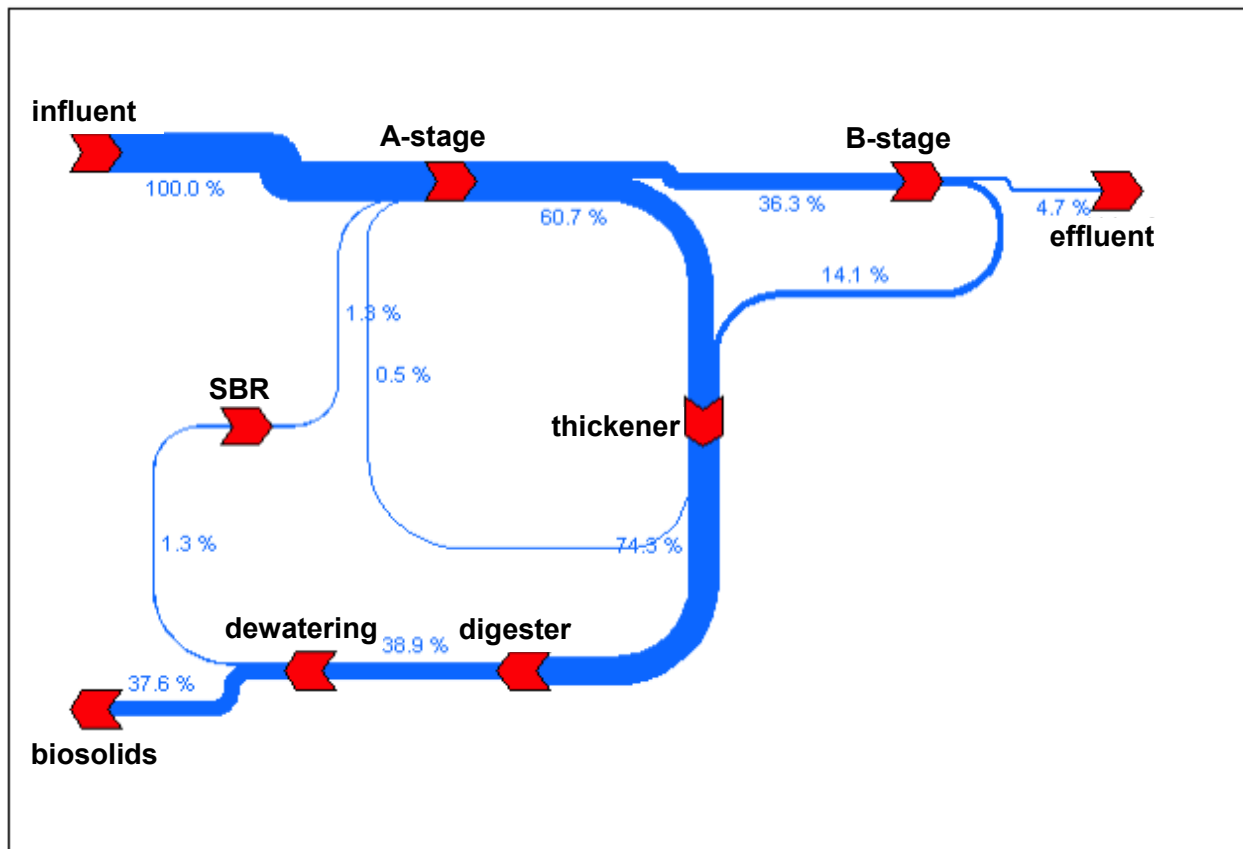

Carbon Removal

Blue Plains AWTP

- 370 mgd (AA) to 518 mgd (Max Day)
- TN < 7.5 mg/l & TP < 0.18 mg/l
- Future TN ~ 3 mg/l peak annual flows
- 12°C winter monthly average

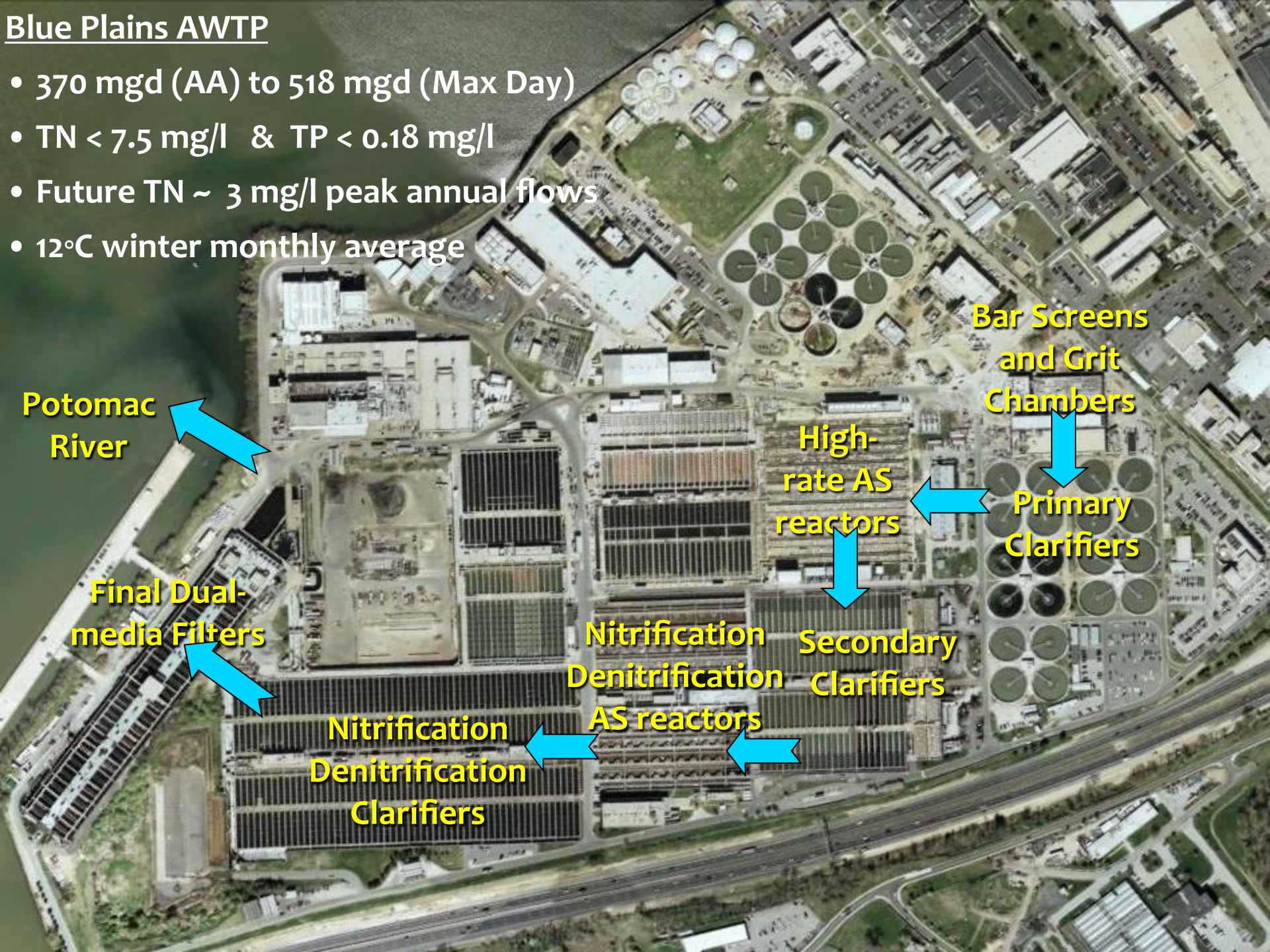

Potomac River

Bar Screens and Grit Chambers

Primary Clarifiers

High-rate AS reactors

Secondary Clarifiers

Nitrification Denitrification AS reactors

Nitrification Denitrification Clarifiers

Final Dual-media Filters



Fundamentals of Nitrification - Denitrification

**Autotrophic
Aerobic Environment**

**Heterotrophic
Anoxic Environment**

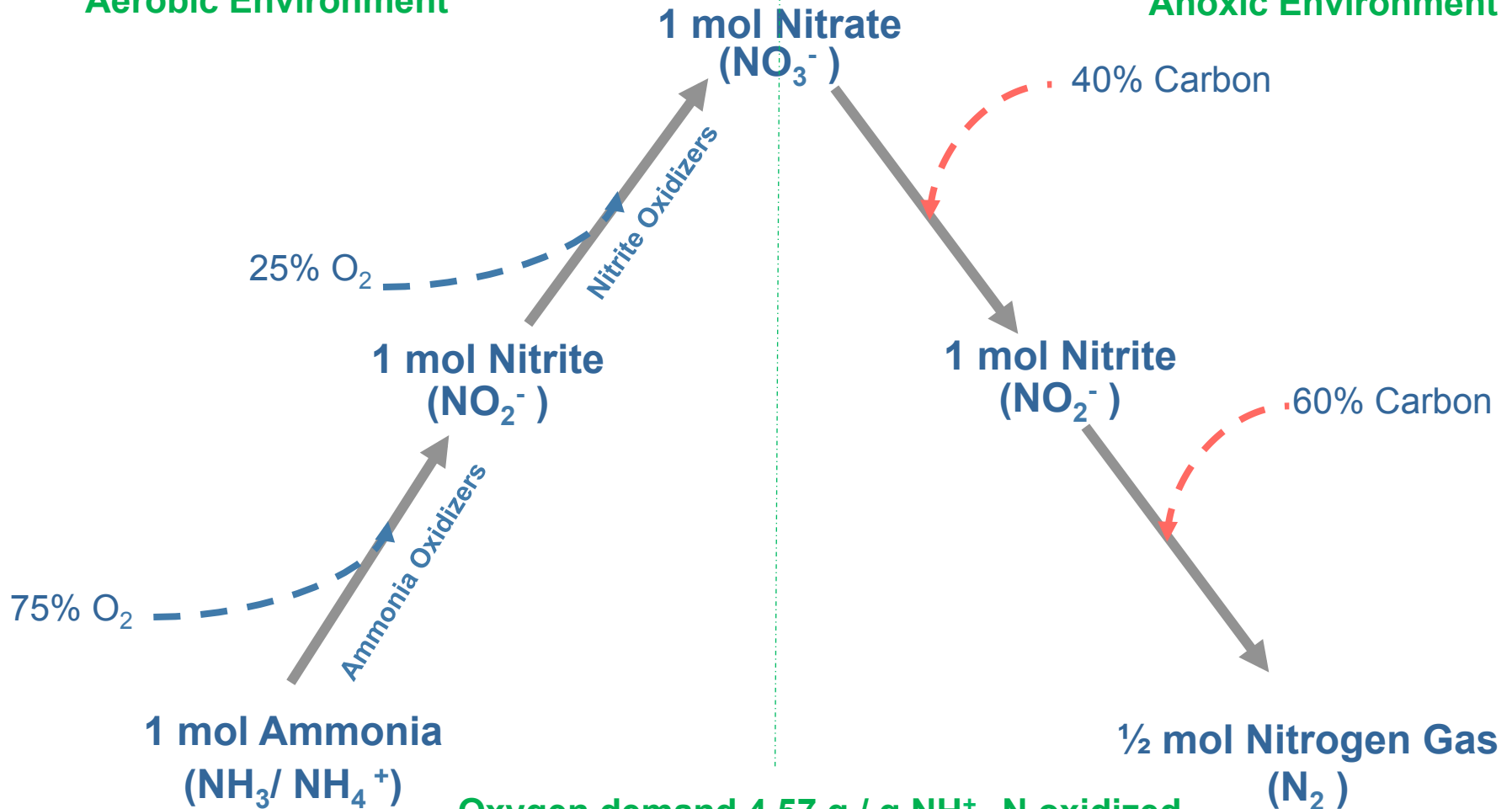

Oxygen demand 4.57 g / g $\text{NH}_4^+\text{-N}$ oxidized
Carbon demand 4.77 g COD / g $\text{NO}_3^-\text{-N}$ reduced



Fundamentals of Deammonification

**Autotrophic
Aerobic Environment**

ANAAMMOX
Anaerobic Ammonium Oxidation
Anoxic Environment
Autotrophic Nitrite Reduction
(New Planctomycete, Strous et. al. 1999)

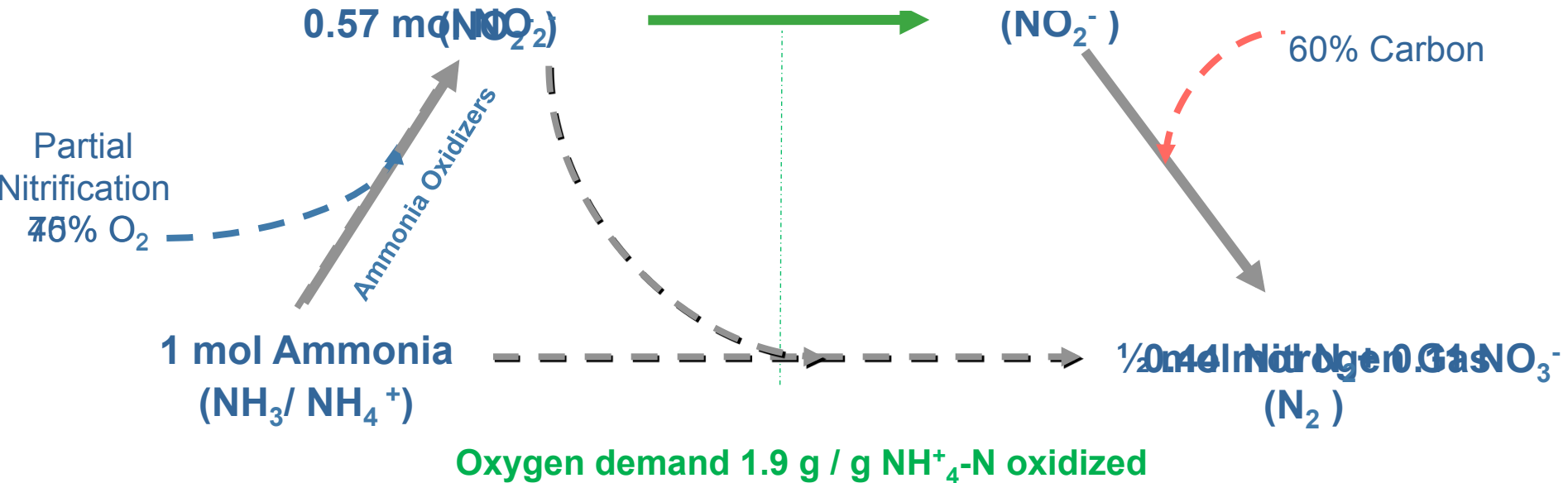
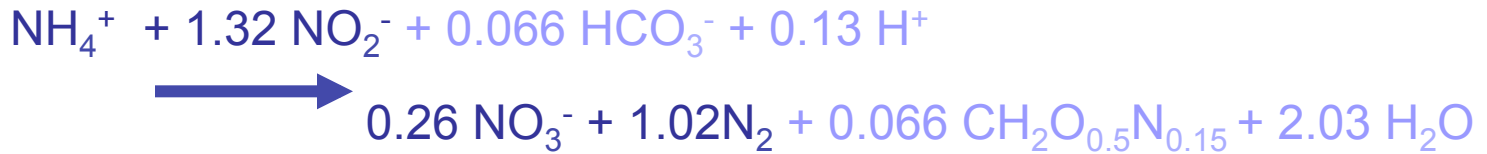

How mature is deammonification technology?

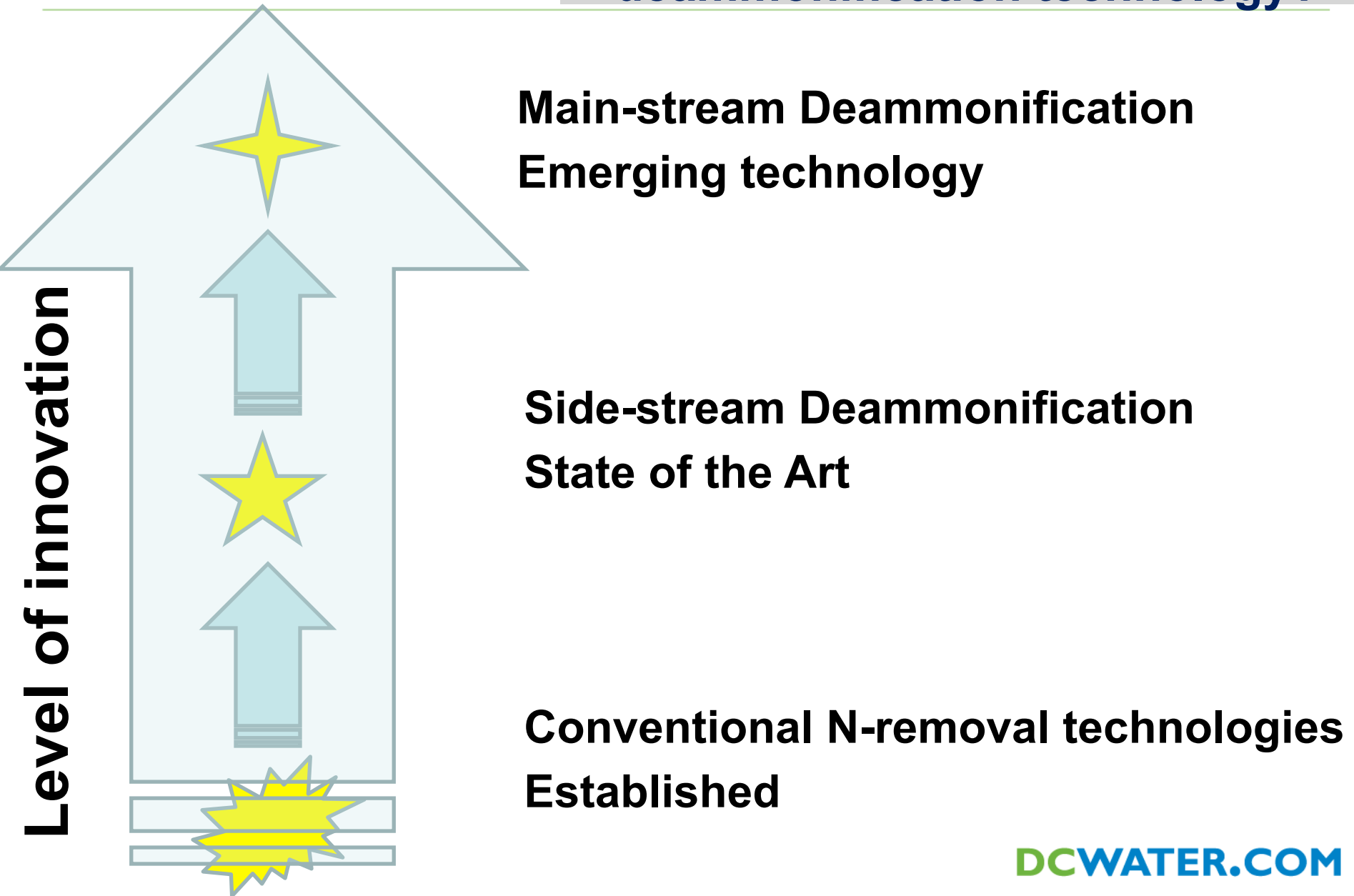

WERF-Mainstream Deammonification

3 different sites and scales

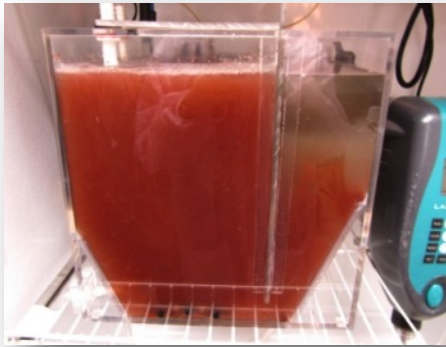

Objective of bench-scale pilot at DC Water

- Investigate fundamental process kinetics and control mechanisms identified for NOB out-selection, AOB and anammox enrichment, development and calibration of process model.



WERF-Mainstream Deammonification

3 different sites and scales

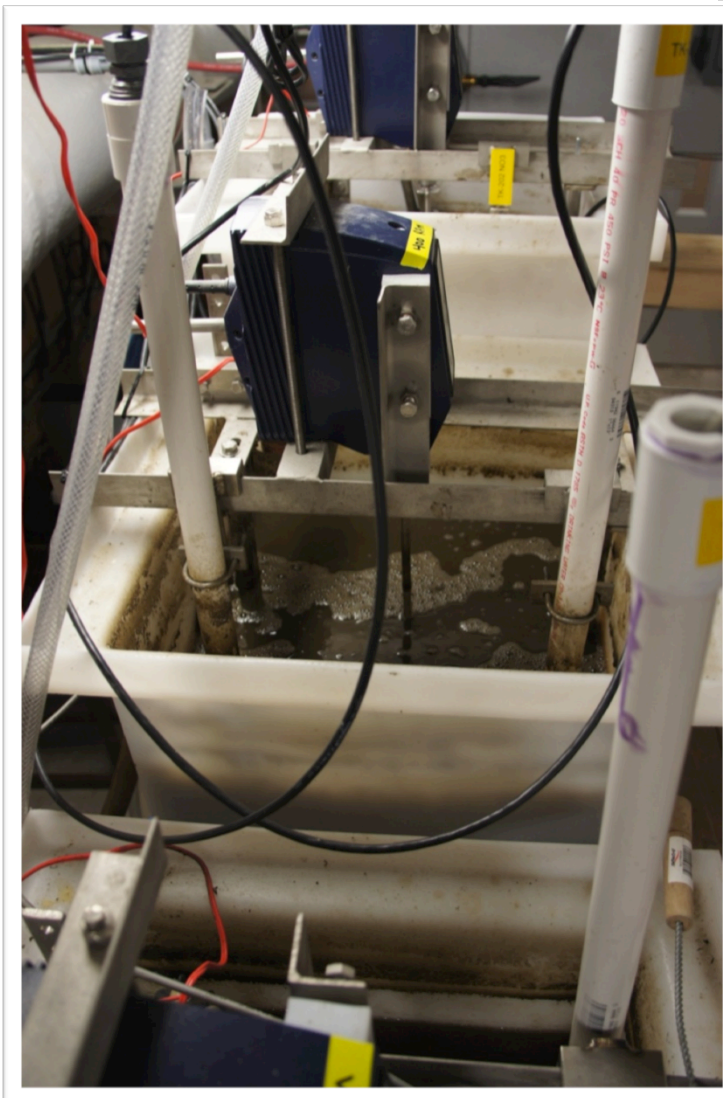

Objective of pilot-scale tests at HRSD, Virginia

- **Focus on NOB out-selection and control optimization to support design work at considered plant.**
- **Biofilm Post-Anoxic Anammox**

WERF-Mainstream Deammonification

3 different sites and scales



Objective of full-scale pilot at WWTP Strass

- **Demonstration** projects at Strass WWTP and Glarnerland WWTP is to demonstrate the feasibility of the deammonification concept, applicable control strategies.

Our Recipe

- Anammox
 - Anammox Bioaugmentation
 - Anammox Retention
- AOB
 - AOB Bioaugmentation
- NOB Out-Selection
 - Aggressive Aerobic SRT Management
 - Ammonia Residual
 - High DO
 - Intermittent Aeration
 - Rapid Transitions to Anoxia
- Effluent Polishing

Our Recipe

- Anammox
 - Anammox Bioaugmentation
 - Anammox Retention (long SRT maintained in granules or biofims)
- AOB
 - AOB Bioaugmentation

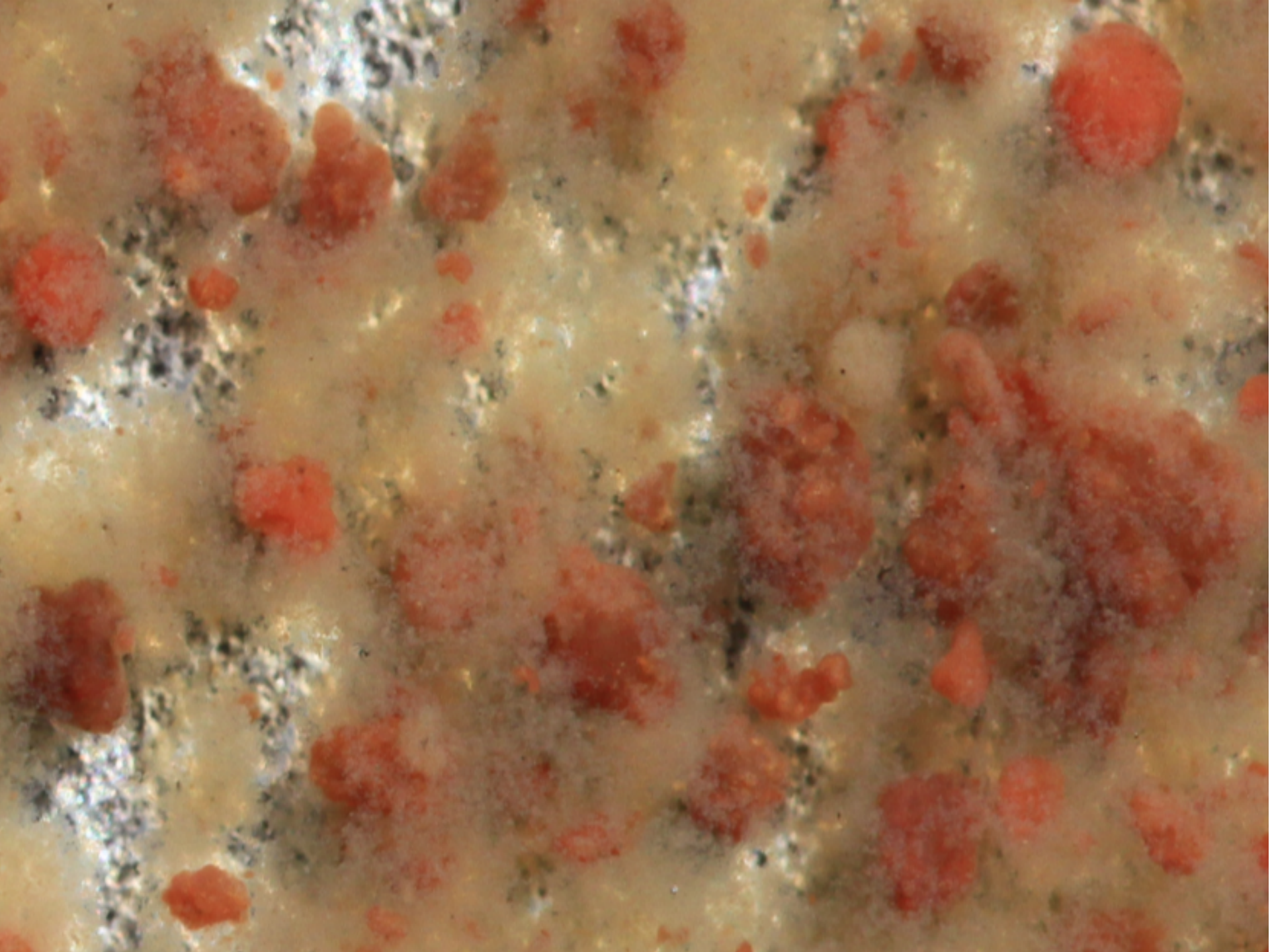

Cyclone, Sieve or Biofilm Media?

Three anammox retention procedures

- 1) Cyclones- Strass
- 2) Sieves- Blue Plains
- 3) Biofilm Media- HRSD

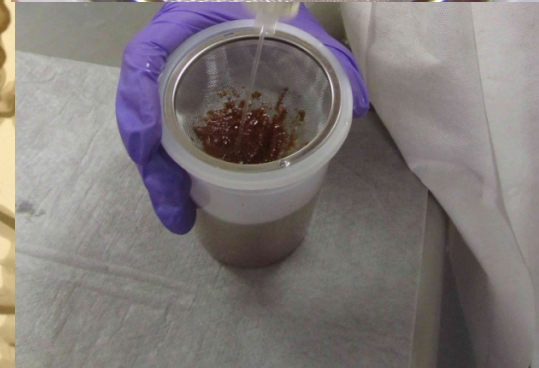

selective SRT

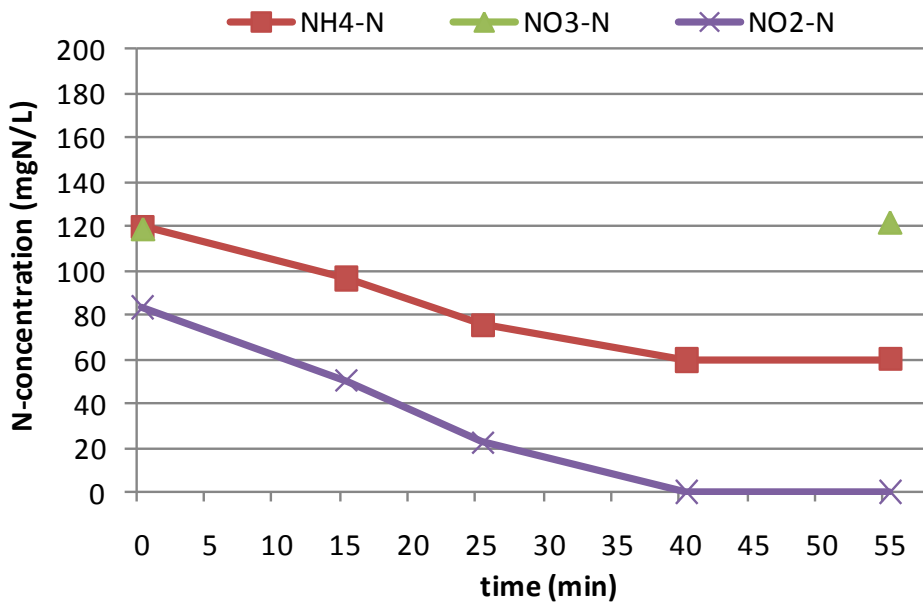
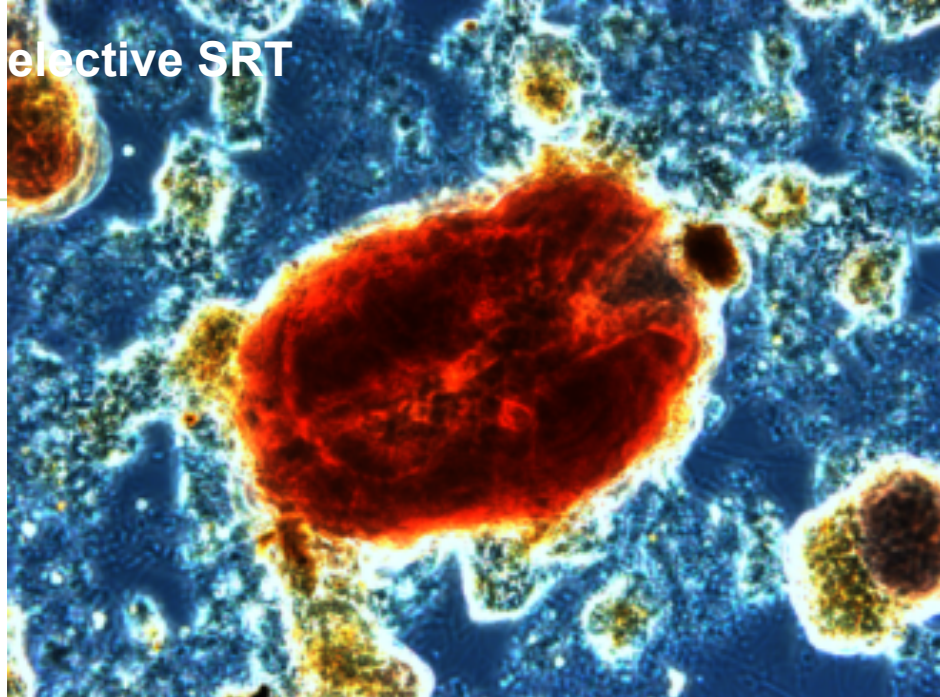

cyclone under-flow (recycled)

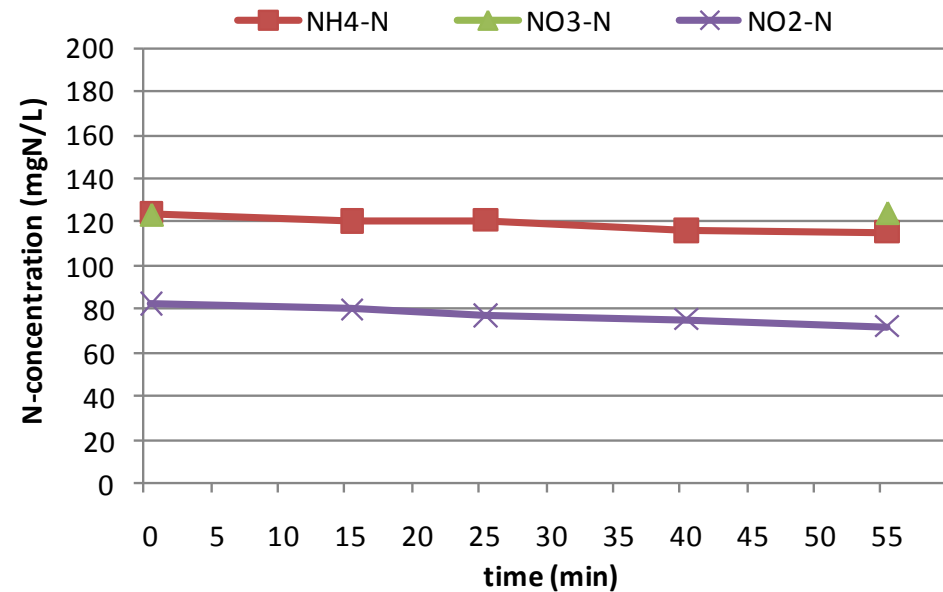

and overflow (wasted)

Our Recipe

- NOB Out-Selection
 - Aggressive Aerobic SRT Management
 - Ammonia Residual
 - High DO
 - Intermittent Aeration
 - Rapid Transitions to Anoxia
- Effluent Polishing

Oxygen Affinity

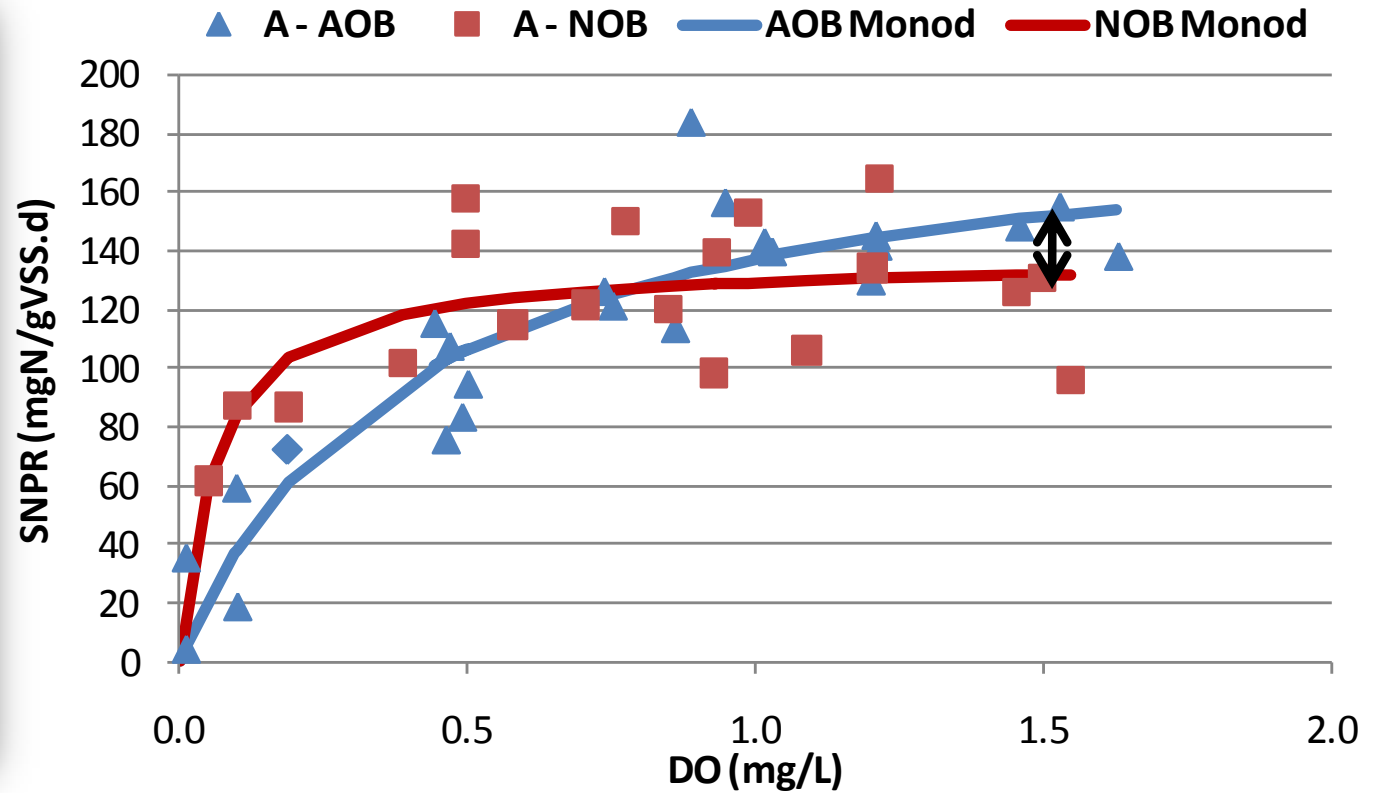

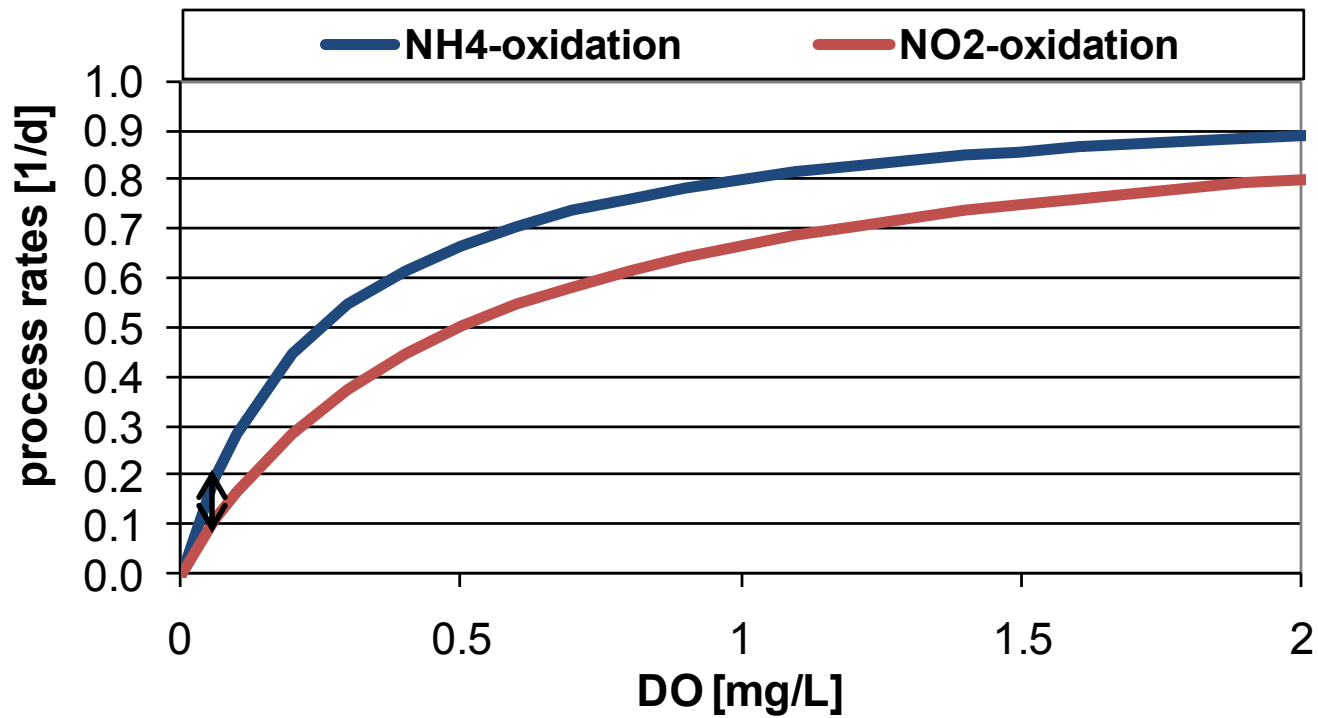

	AOB-growth Monod	NOB-growth Monod
μ_{\max} [1/d]	0.9	0.7
Arrhenius	1.07	1.06
k_O [mg DO/L]	0.25	0.50

Frequently used parameter set for maximum AOB- and NOB-growth rates and oxygen affinity (K_O)

Oxygen and Nitrogen Affinities

From:
Current WERF Study

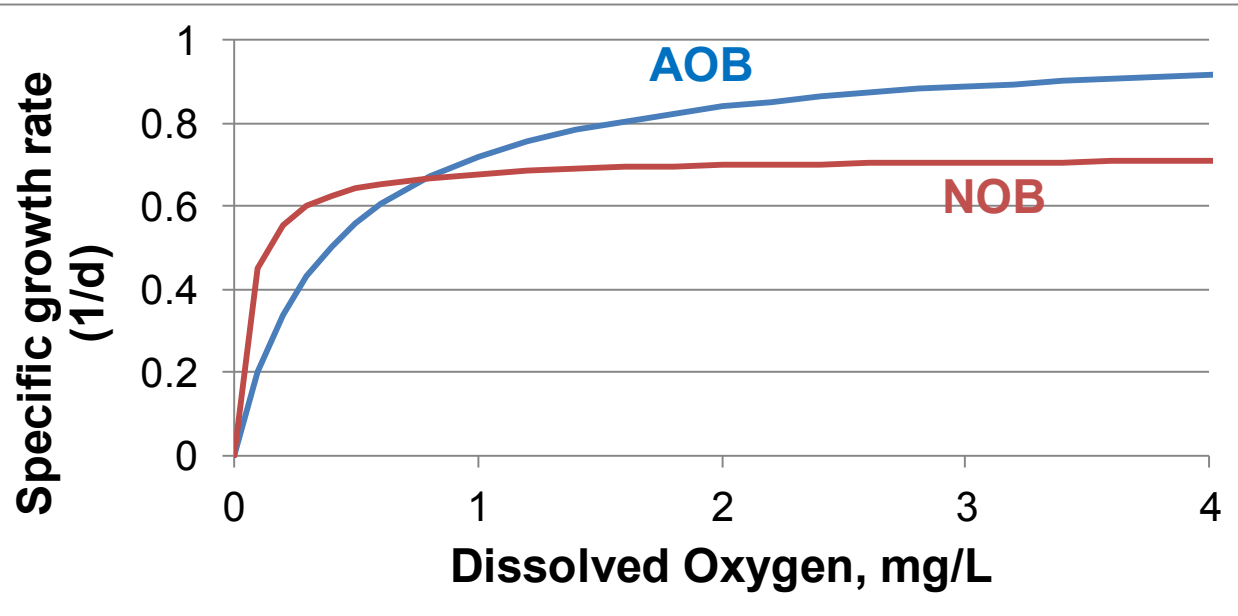

Extracted From:
Chandran and Smets (2005)
Water Research, **39**, 4969

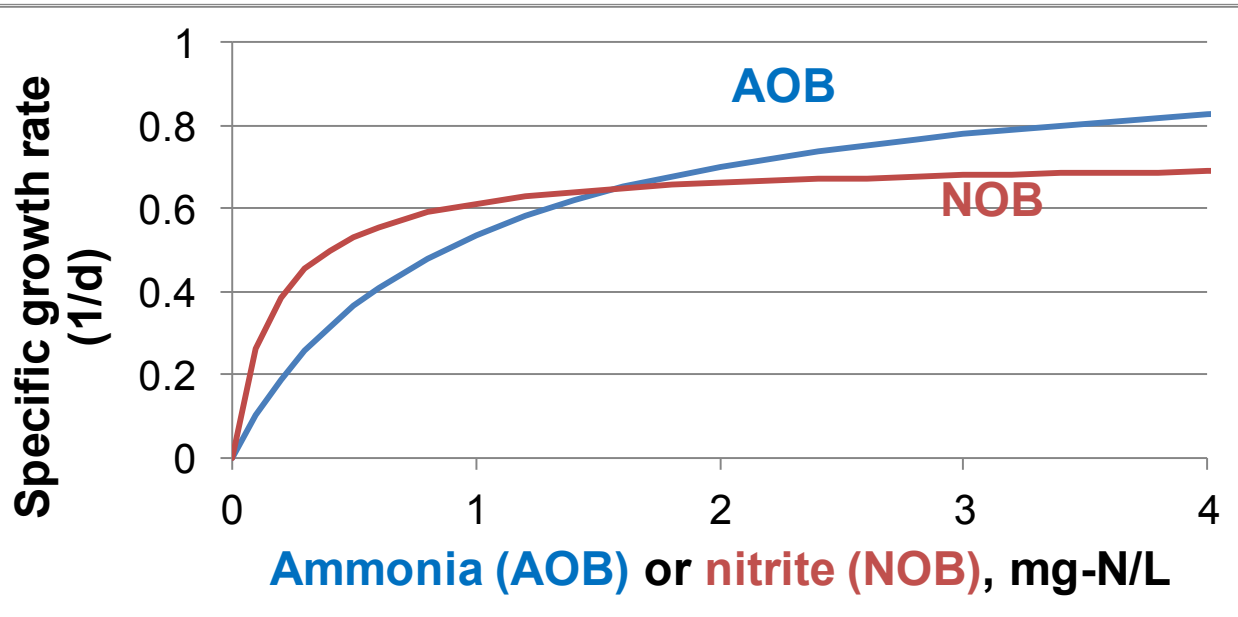

DC Water Trials

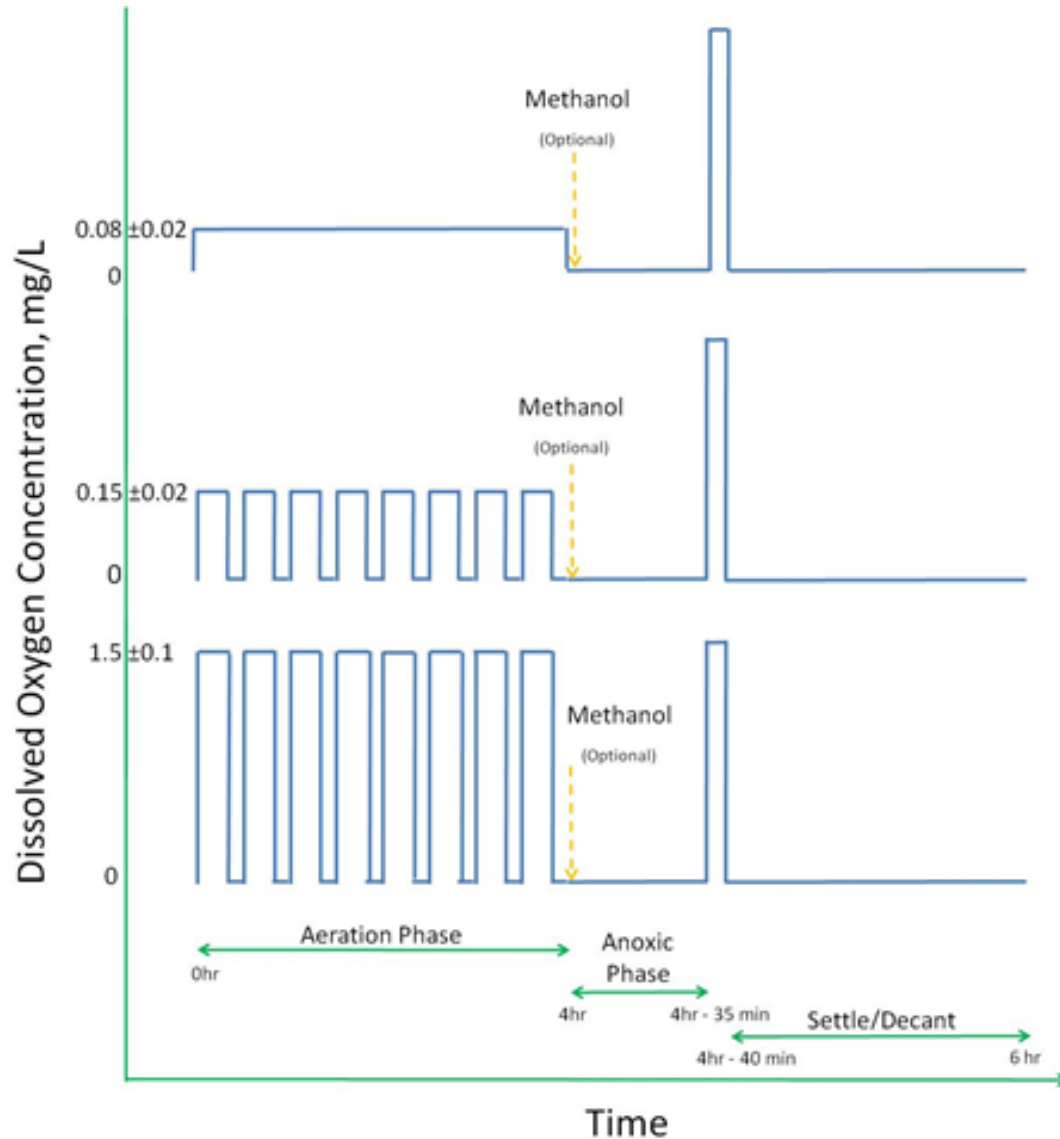

Low/Constant DO

Low/Intermittent aeration

High/Intermittent aeration

Dissolved Oxygen Slope and Profiles

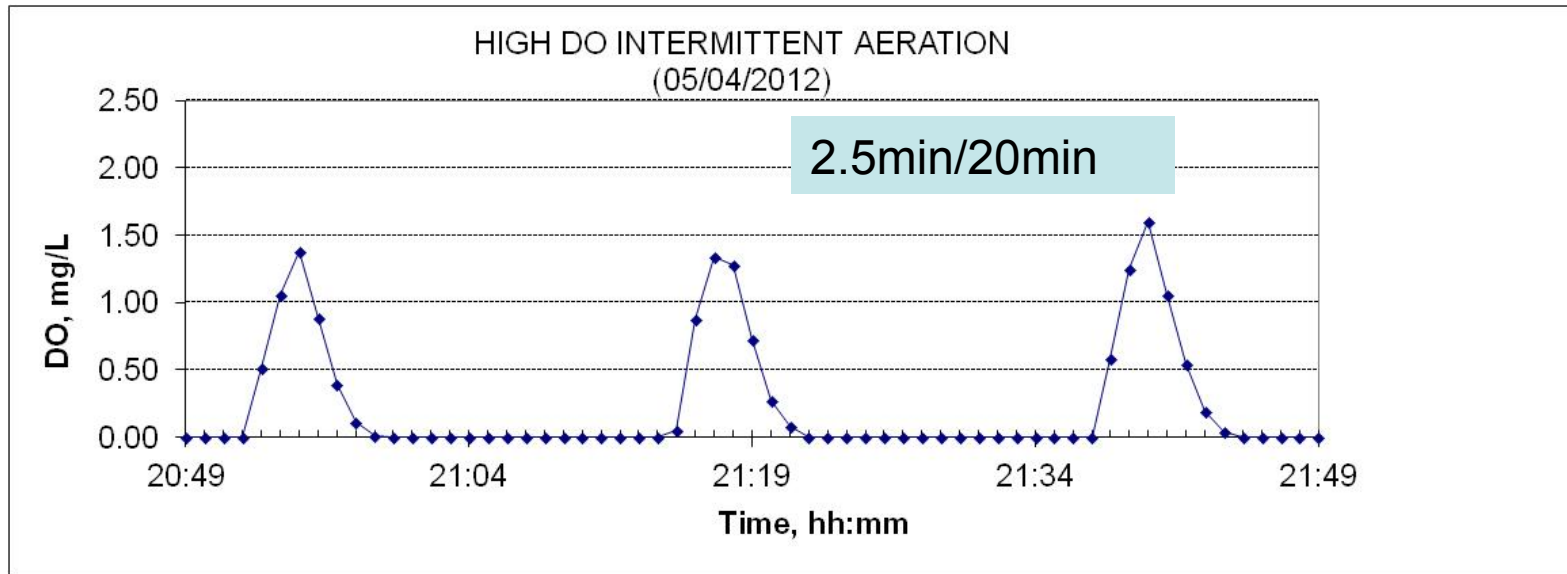

HIGH DO Intermittent Air – “Anammox Activity”

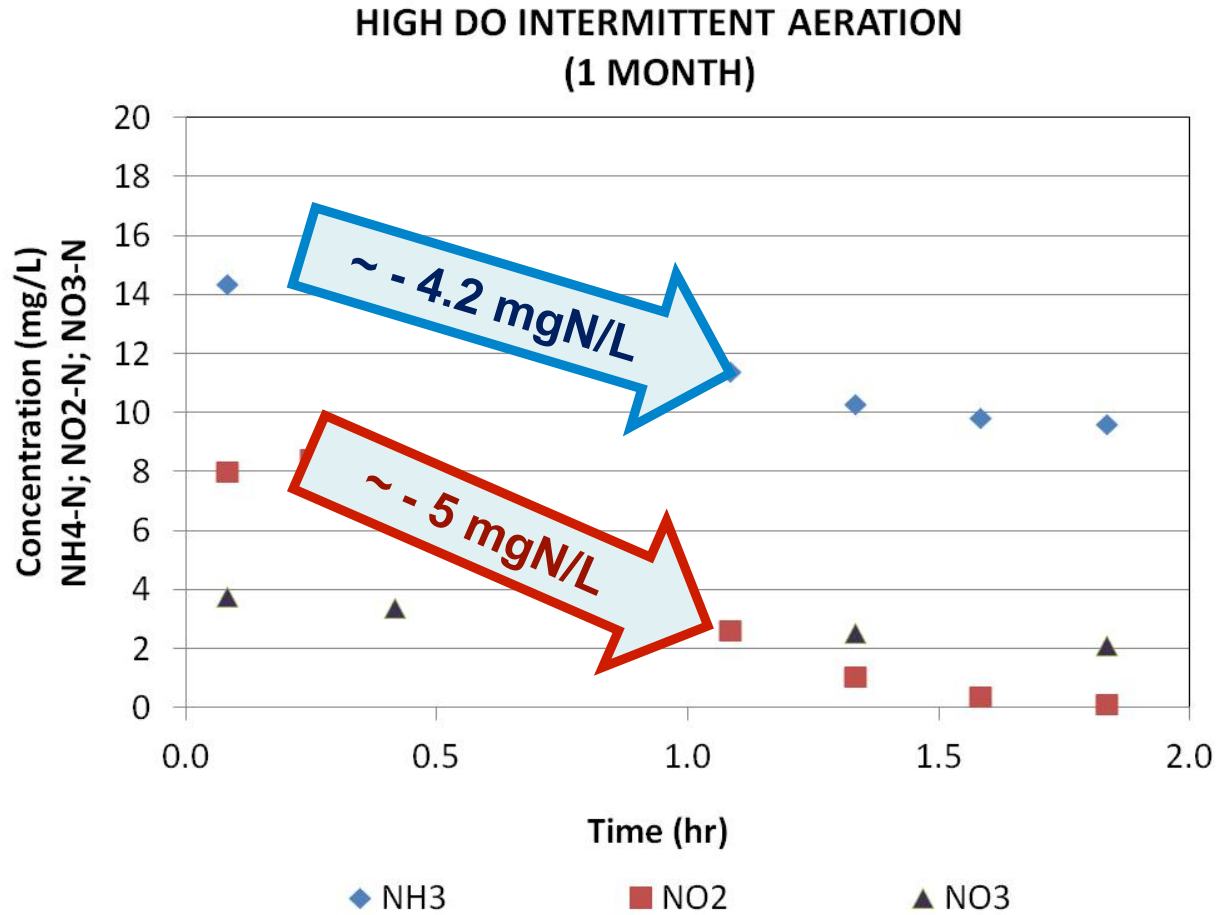

HIGH DO Intermittent Air – “N Profiles”

2 mg/L Ammonia Residual

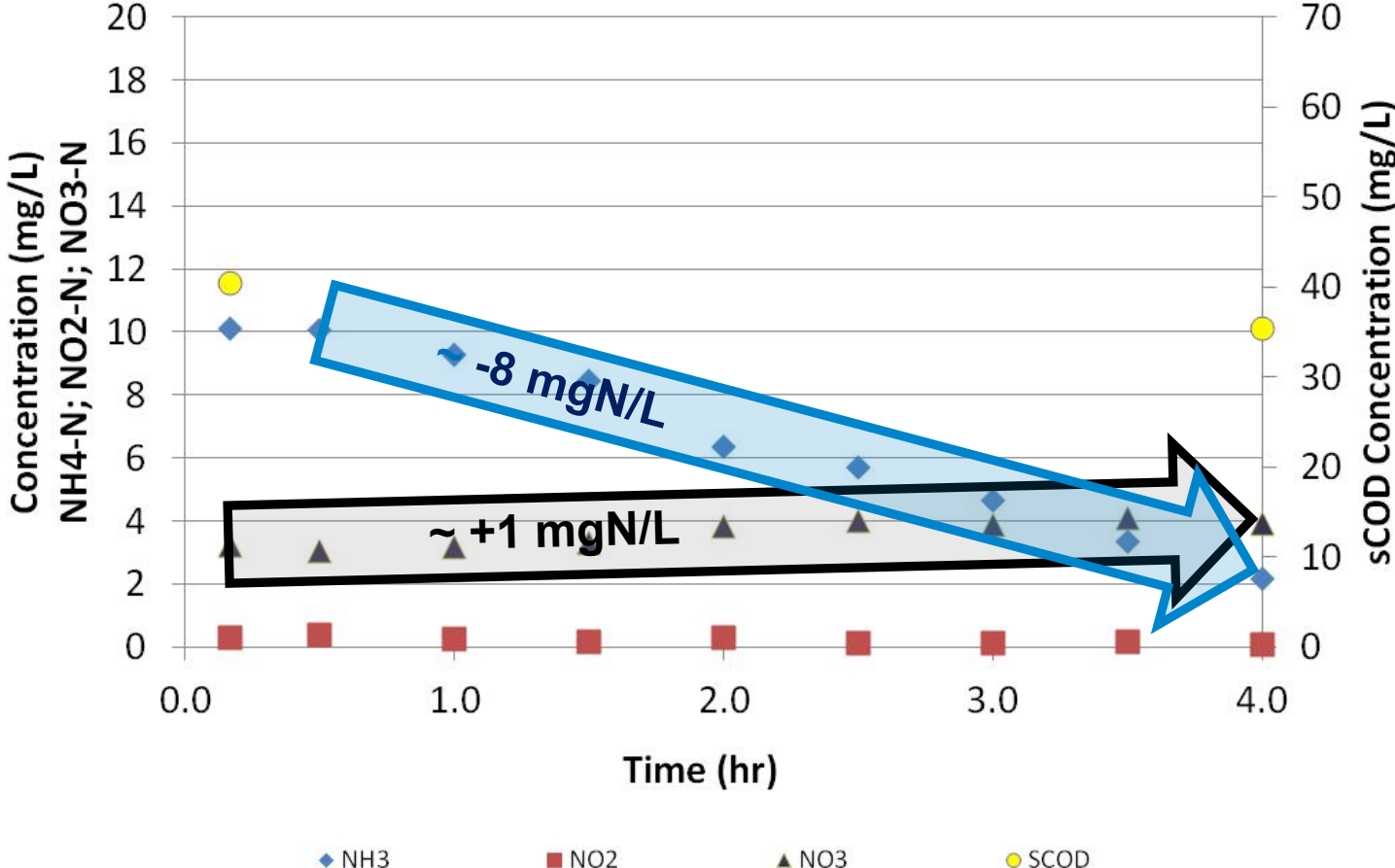

HIGH DO Intermittent Air – “N Profiles”

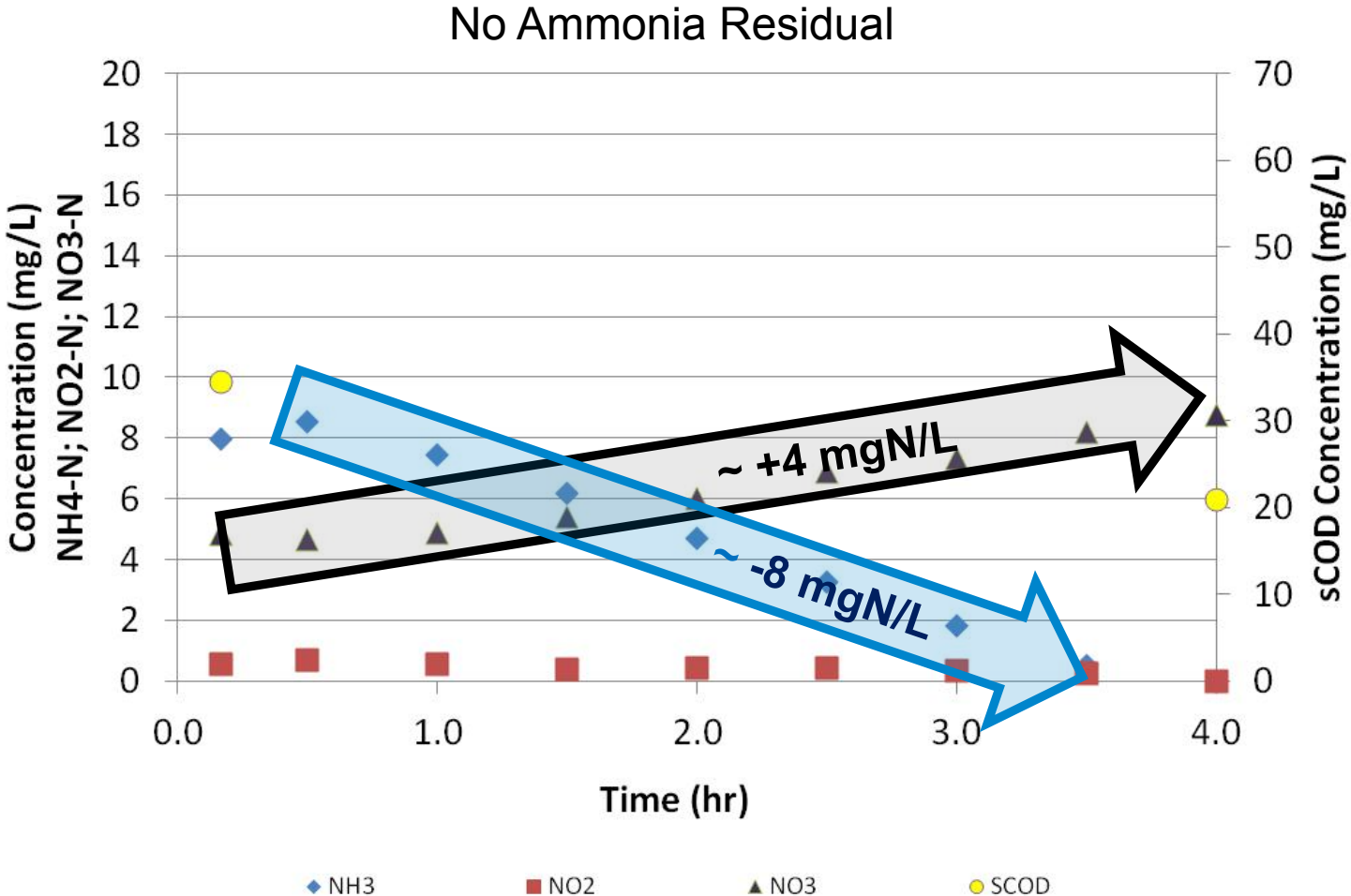

HRSD Process Schematic

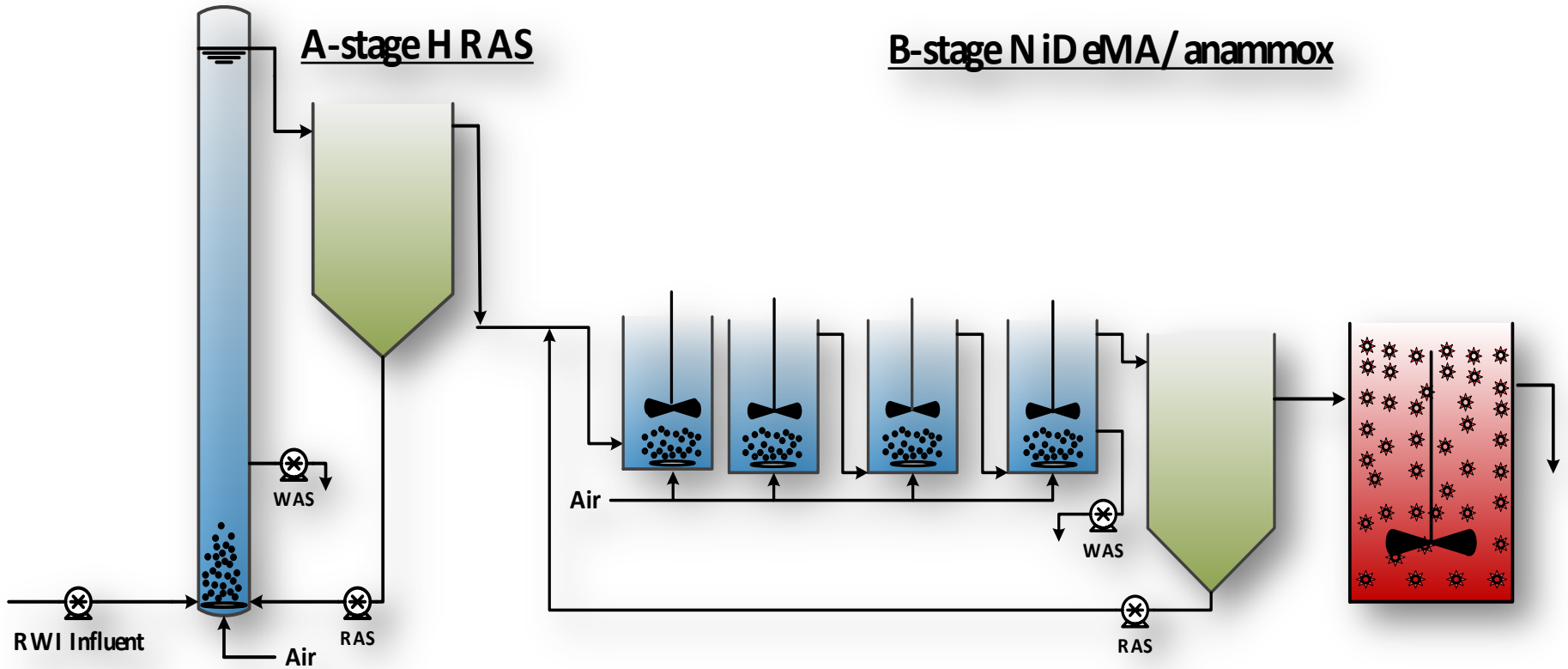

Ammonia vs NOx (AVN) Controller

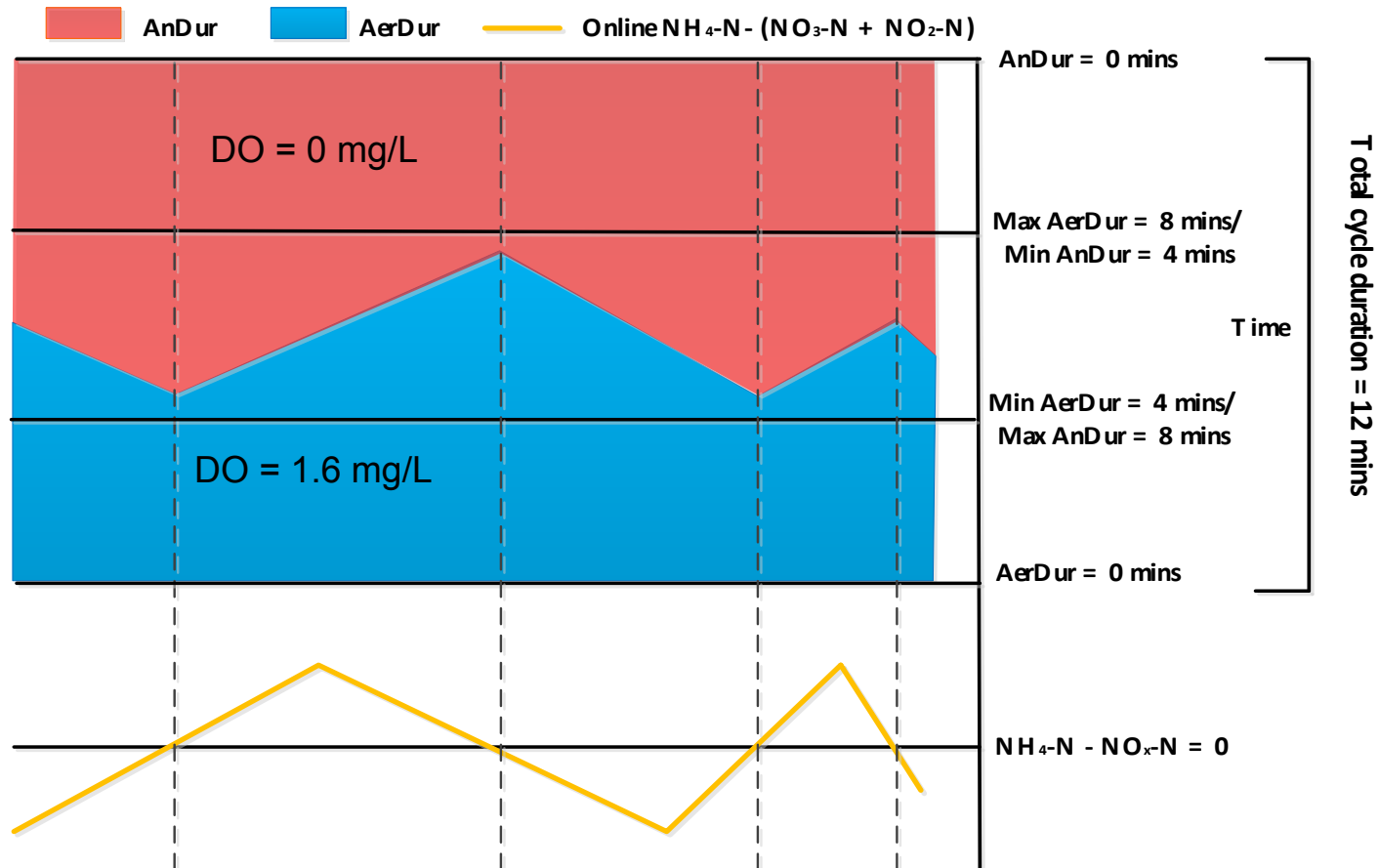

AVN control

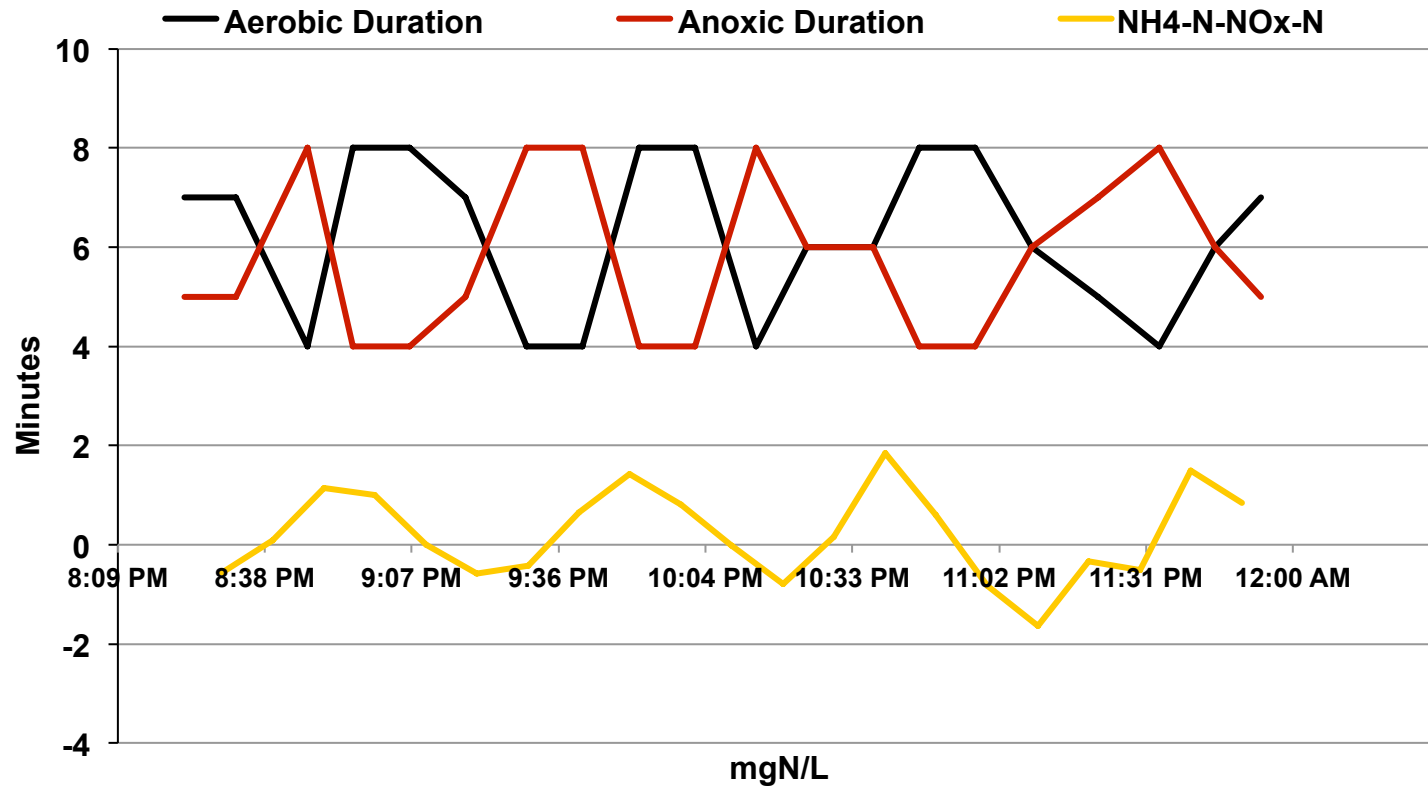

Process Performance

Nitrification/ Denitritation



Post-Anoxic Anammox MBBR

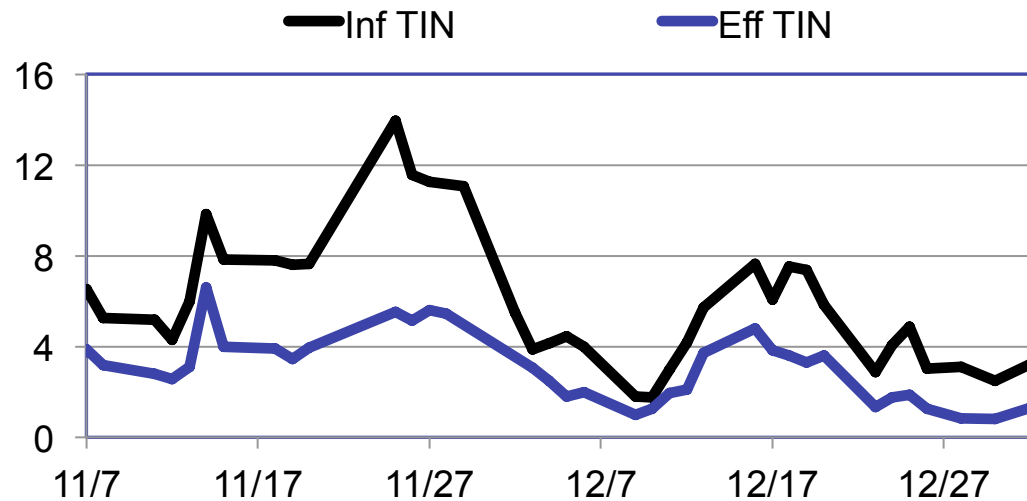
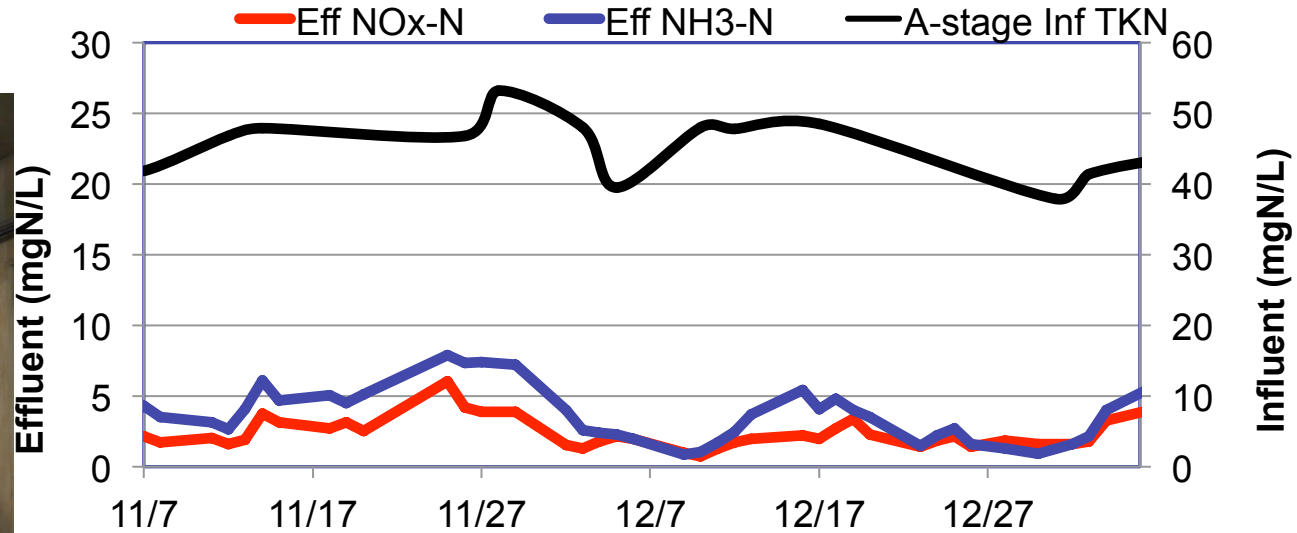

Strass Demonstration

- Carousel type aeration tank at Strass WWTP providing a DO-range of 0 to 1.7 mg/L along the flow-path.

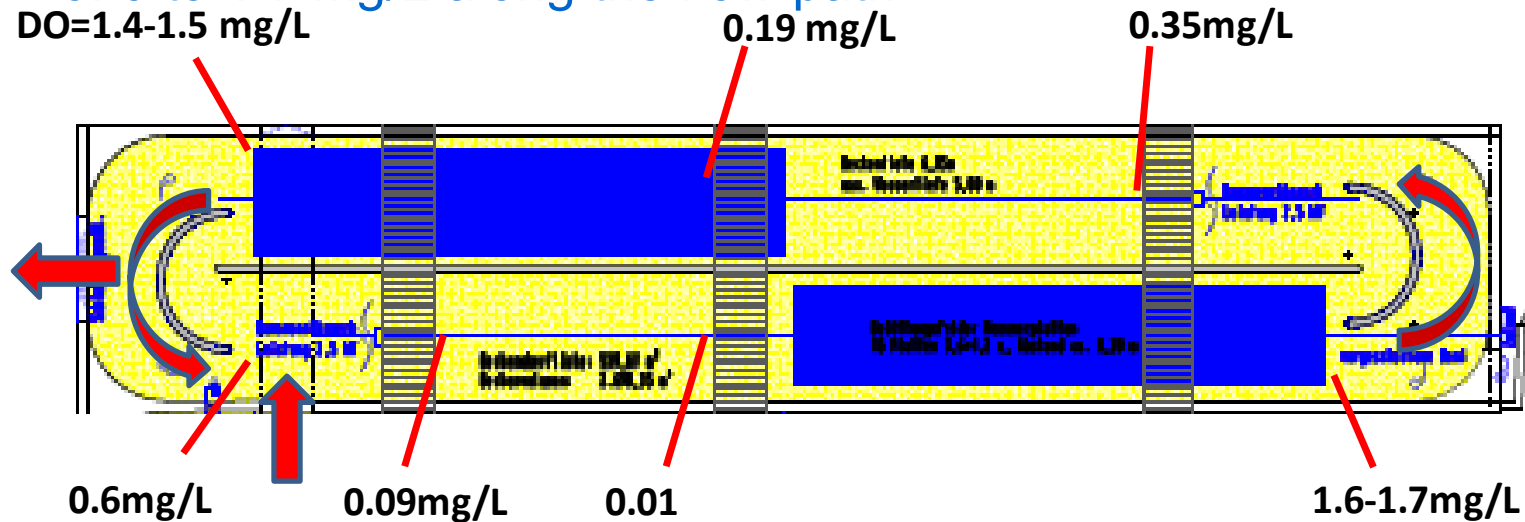

Cyclones installed at the B-stage in Strass, Cyclone A (left), Cyclone B since early September 2011 (right).



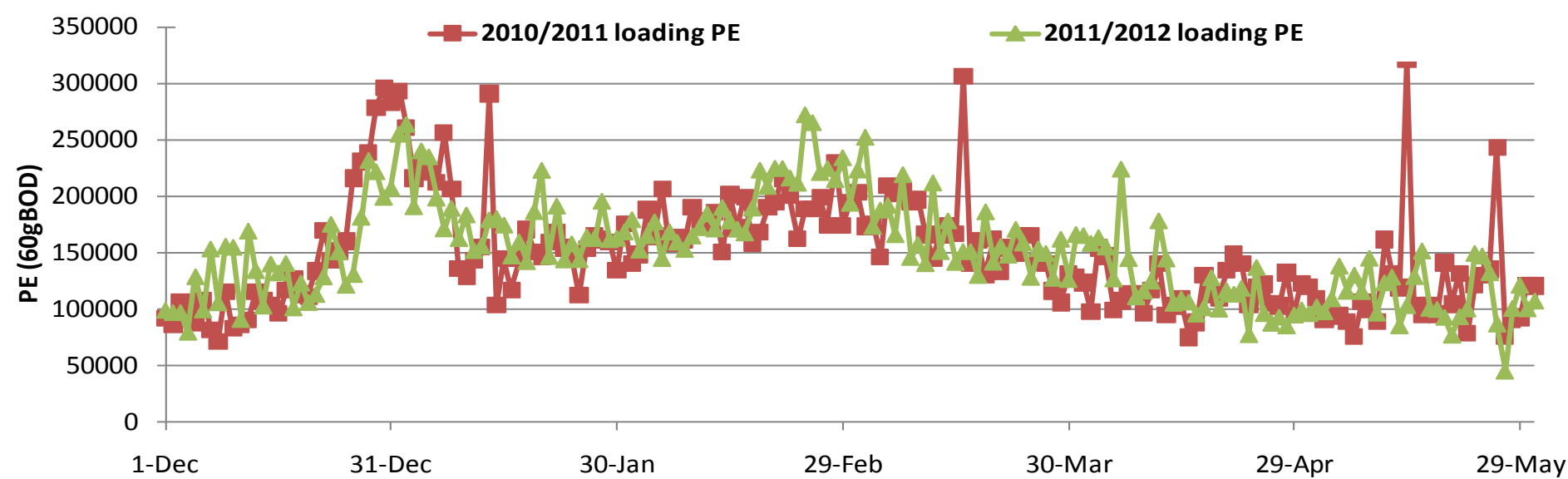

plant loading profiles (PE) before and after project start

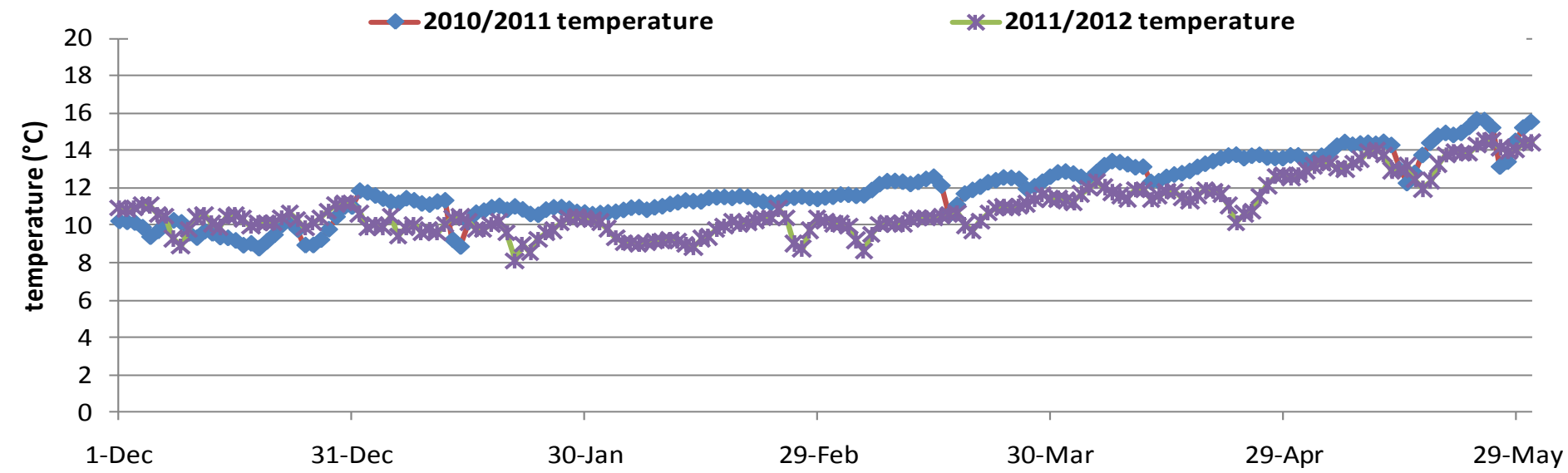

comparison of temperature profiles (°C)

The last samples show ammonia removal during anaerobic activity test (anammox activity)

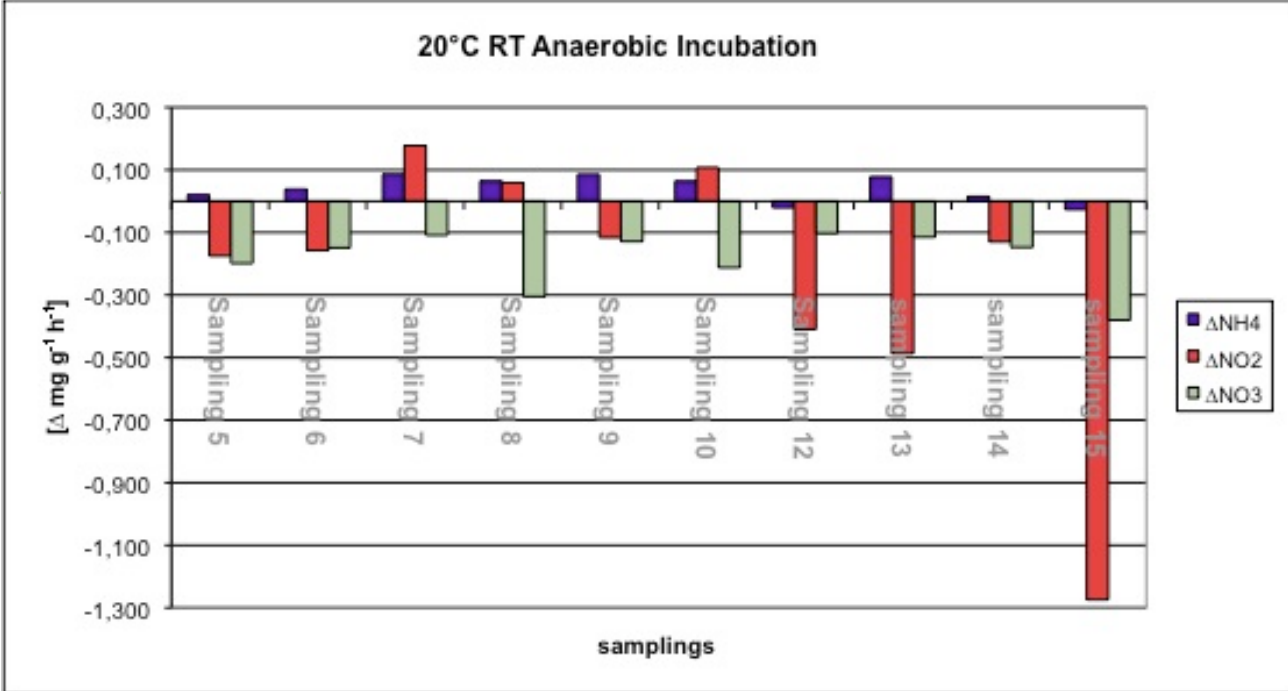

Only 25% of NOx produced from ammonia oxidation is converted to nitrate during aerobic activity test of the last sample

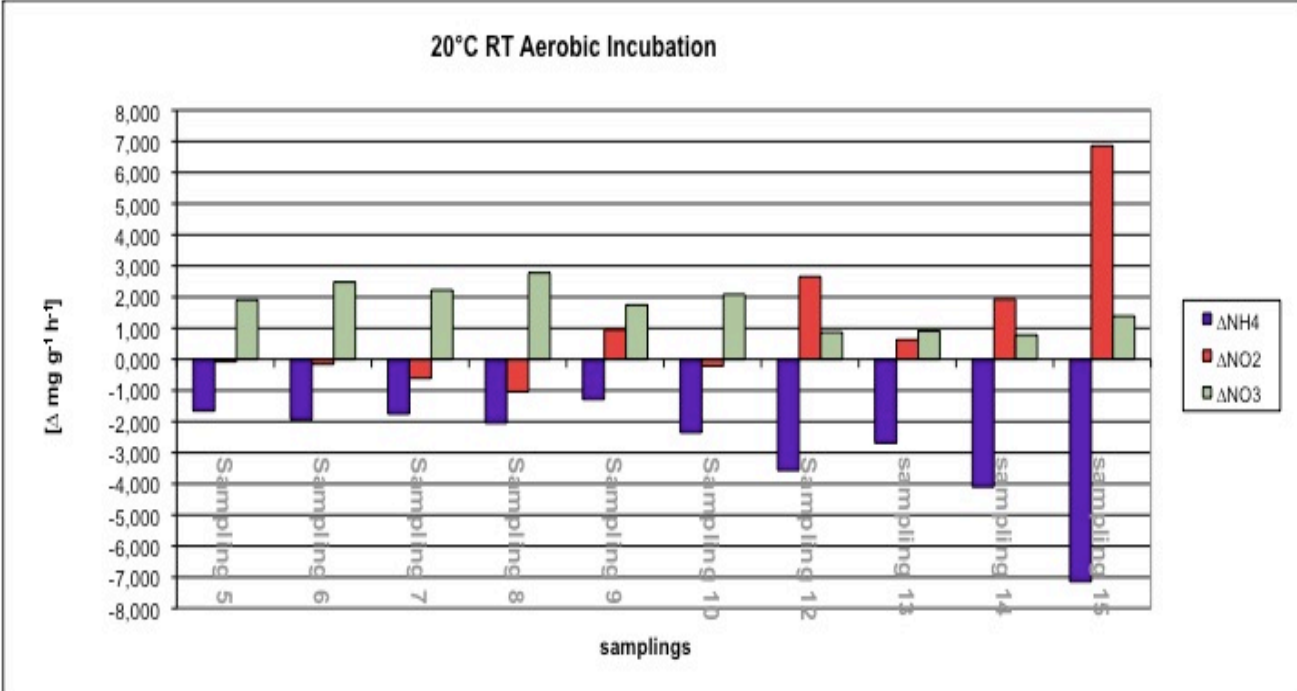

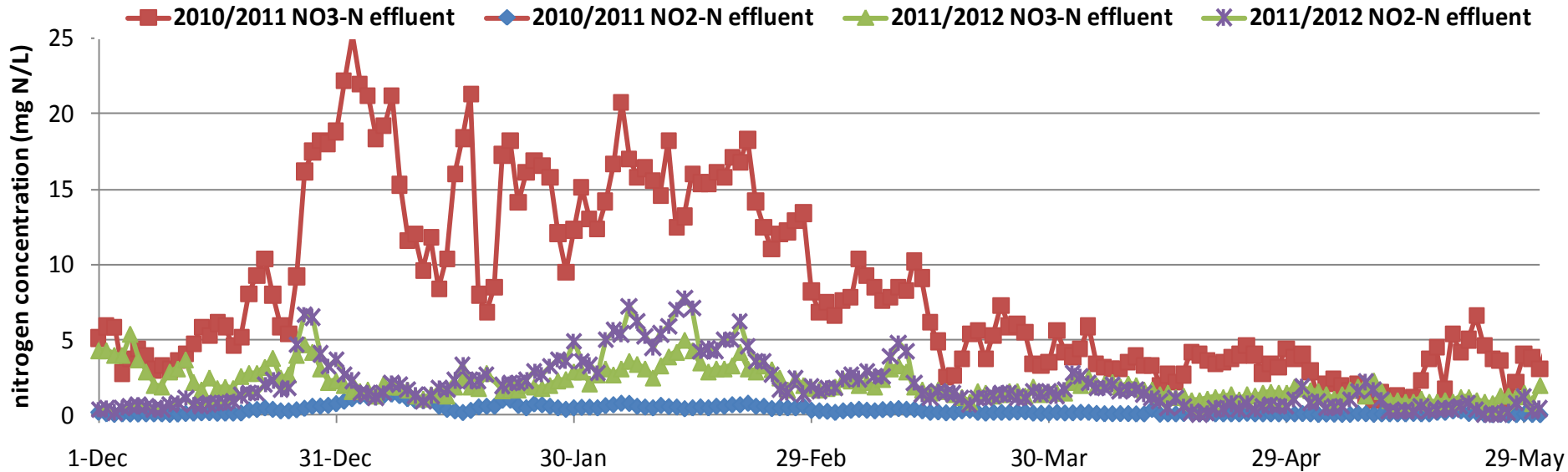

Comparison of this year's and last year's operational data of the full-scale pilot Strass indicating advanced NOB-repression (typically high nitrate level at Christmas peak-load; similar temperature conditions of ca. 10°C, load conditions and ammonia effluent concentrations of ca. 2-5 mgN/L for both years)

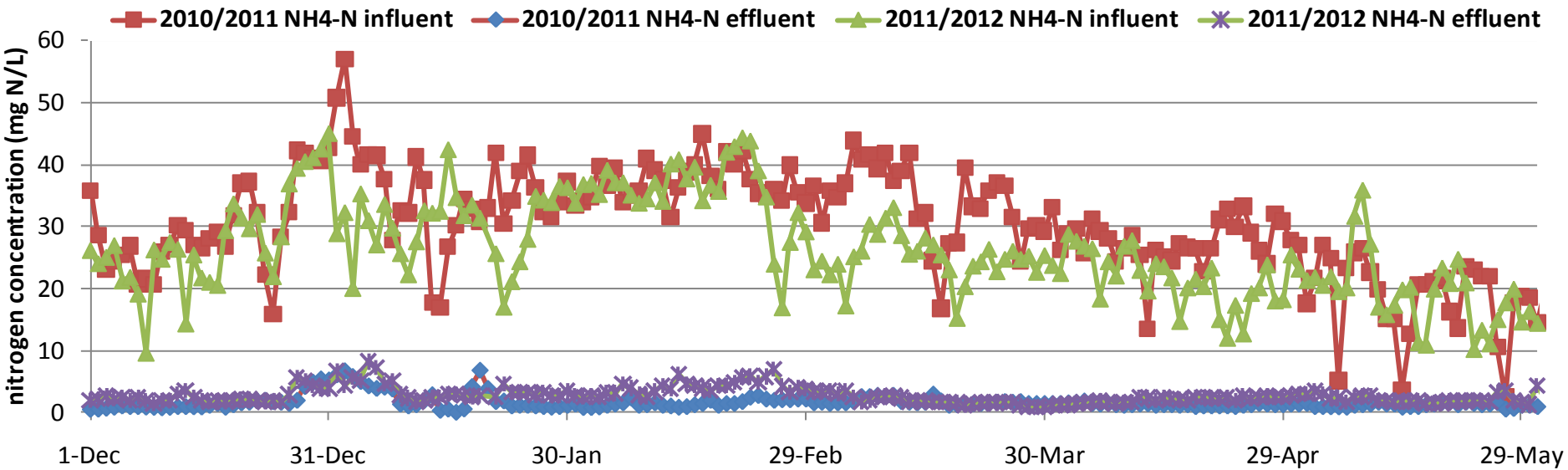

MODEL PARAMETER CALIBRATION

Simulation Results

DO Profiles

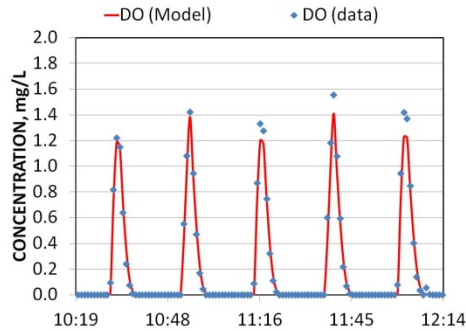

N Profiles

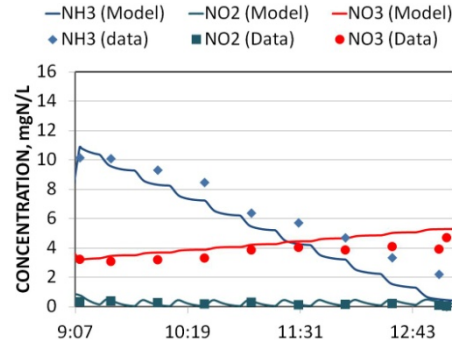

AMX Activity

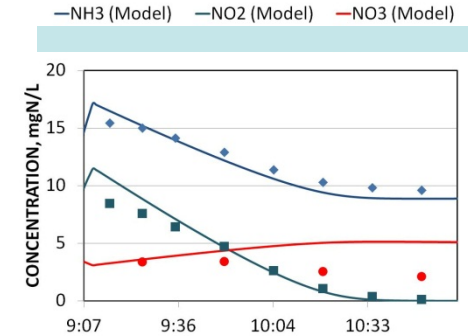

High/Intermittent
aeration

	AOB-growth	NOB-growth
	Monod	Monod
$\mu_{\max} * X_a / Y_a$	193	137
k_o [mg DO/L]	0.40	0.06

Specific nitrogen process rates for AOB and NOB yielded from constant DO-tests

The People

Olawale Akintayo

Charles Bott

Ryder Bunce

Kartik Chandran

Michael Desta

Norman Dockett

Haydee De Clippeleir

M. Gomez Brandon

Dana Fredericks

Mofei Han

Martin Hell

Becky Holgate

Rebecca Jimenez

Hansa Keswani

David Kinnear

Yi Wei Ma

Matthew Michaelis

Mark Miller

Sudhir Murthy

Geert Nyhuis

Sylvia Okogi

Ahmed Omari

Maureen O'Shaughnessy

Hong Keun Park

Sabine Podmirseg

Pusker Regmi

Rumana Riffat

Andrew Shaw

Beverley Stinson

Imre Takacs

Claire Welling

Bernhard Wett