

Thank you to our Patrons



We will begin our presentation in a few minutes...



Leadership and Excellence in Environmental Engineering and Science



L31 N Seepage Barrier (8.5 SMA Segment)

Miami-Dade County, Florida

By Juan H. Vázquez, PE, PH, BCEE

06/07/2023

**2023 Excellence in Environmental Engineering and Science
Competition
Honor Award - Environmental Sustainability**



CREDITS

Owner: South Florida Water Management District



Design Team:

- **R.J. Behar & Company, Inc. - Prime (Civil Engineers)**
- **WSP (fka Wood Environmental & Infrastructure) - Geotechnical Engineers**
- **McVicar Consulting, Inc. - Hydrogeological Modeling**
- **Tierra South Florida, Inc. - Geotechnical Exploration**
- **Whidden Surveying and Mapping Inc. - Land Surveyors**

Construction Management: TSFGeo

Contractor: Geo-Solutions, Inc.

AGENDA

- 1. Background**
- 2. Location**
- 3. The Problem**
- 4. Design Process**
- 5. Construction**
- 6. Questions and Answers**



BACKGROUND – PROJECT DATA

8.5 SMA Limited Curtain Wall

- Length - 2.3 miles
- Project Start - 4/26/2021
- Project Bid - \$13,923,000
- Contract days - 360

CEPP New Water Seepage Barrier

- Length - 4.9 miles
- Project Bid - \$42,258,000
- Contract days - 790



BACKGROUND

The elevation change is only 12 to 14 feet from the maximum near Lake Okeechobee to sea level at the southern extent of the Everglades

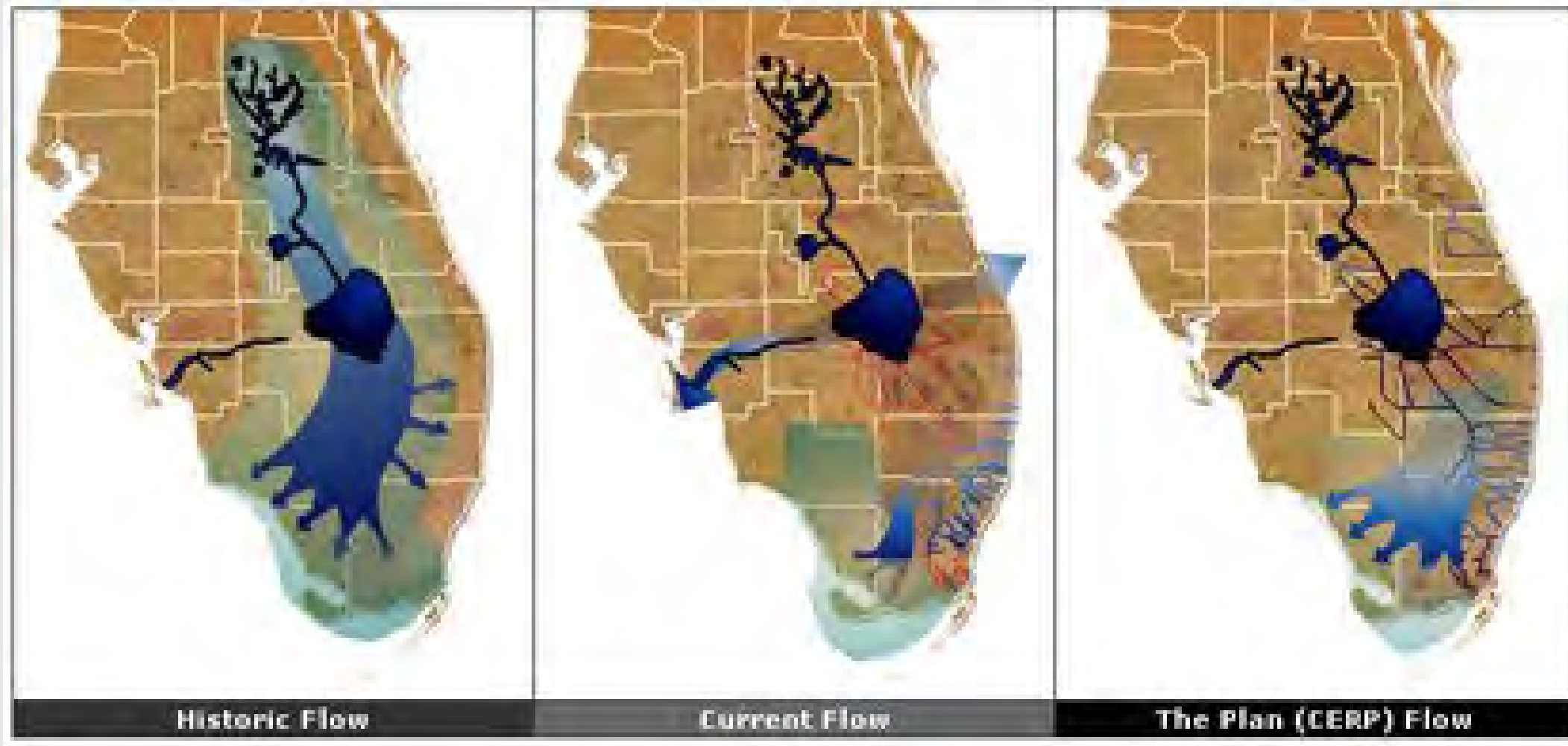

<https://www.nps.gov/ever/learn/nature/hydrologicactivity.htm>

BACKGROUND

L31N Seepage project is part of the Comprehensive Everglades Restoration Plan (CERP)

The construction and operation of the historic system disturbed the natural flow of water into the park, leaving Western Shark River Slough unnaturally wet and NE Shark River Slough unnaturally dry.



General Surface Flow Patterns in South Florida

LOCATION

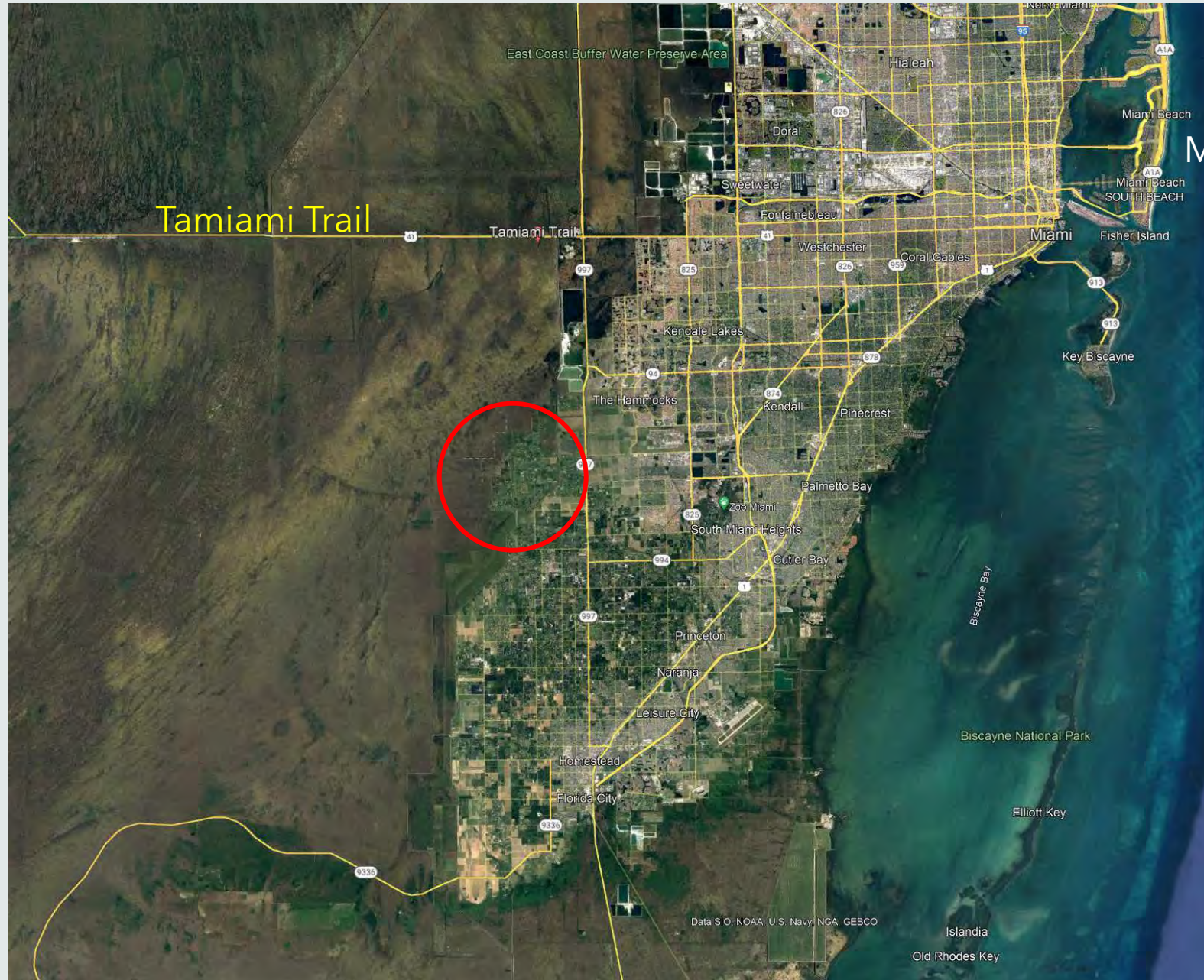

Miami Beach



N

LOCATION

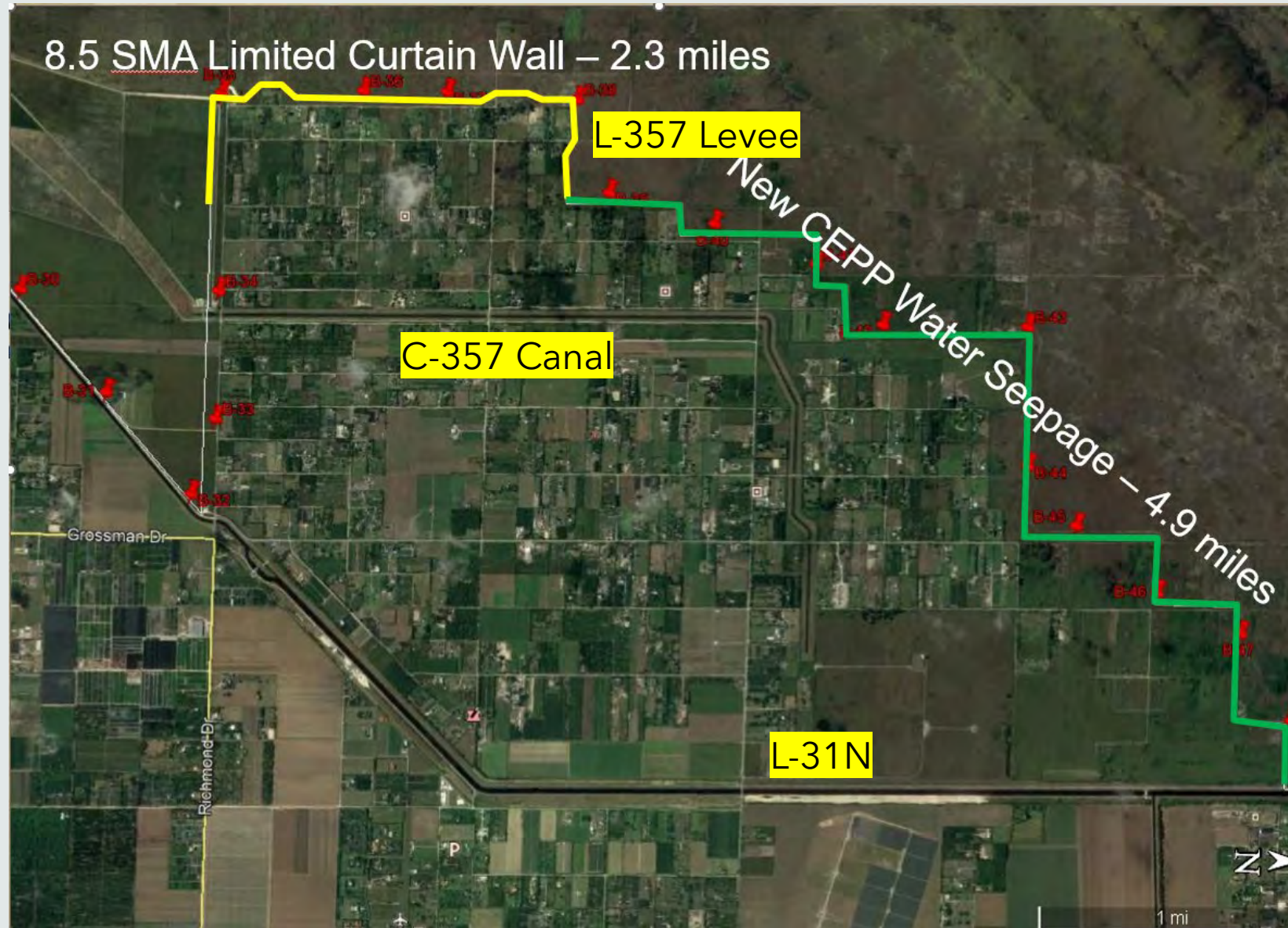

THE PROBLEM

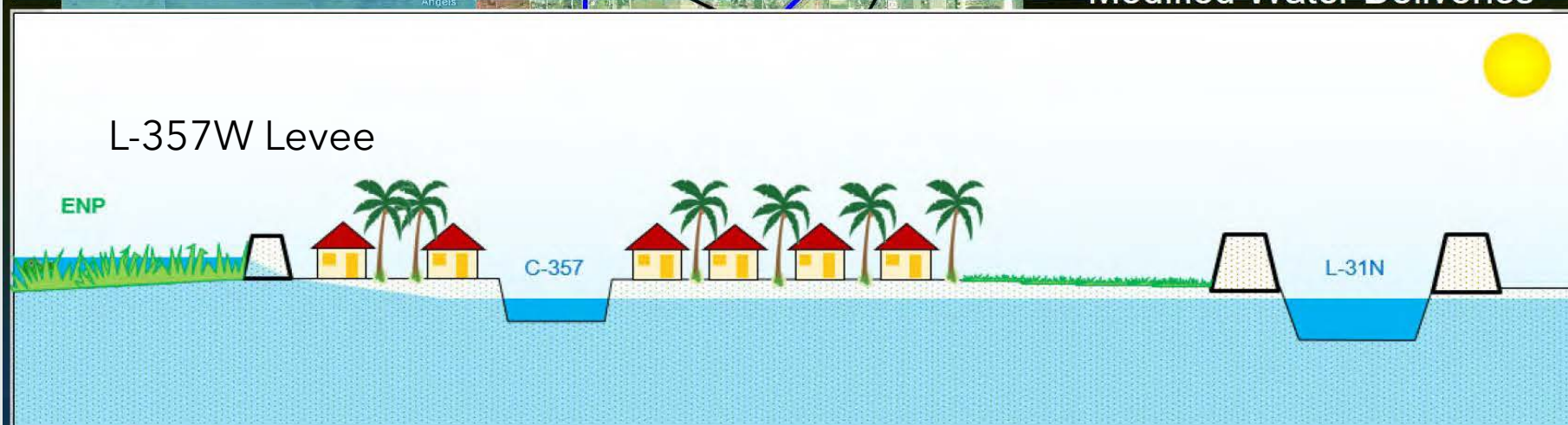
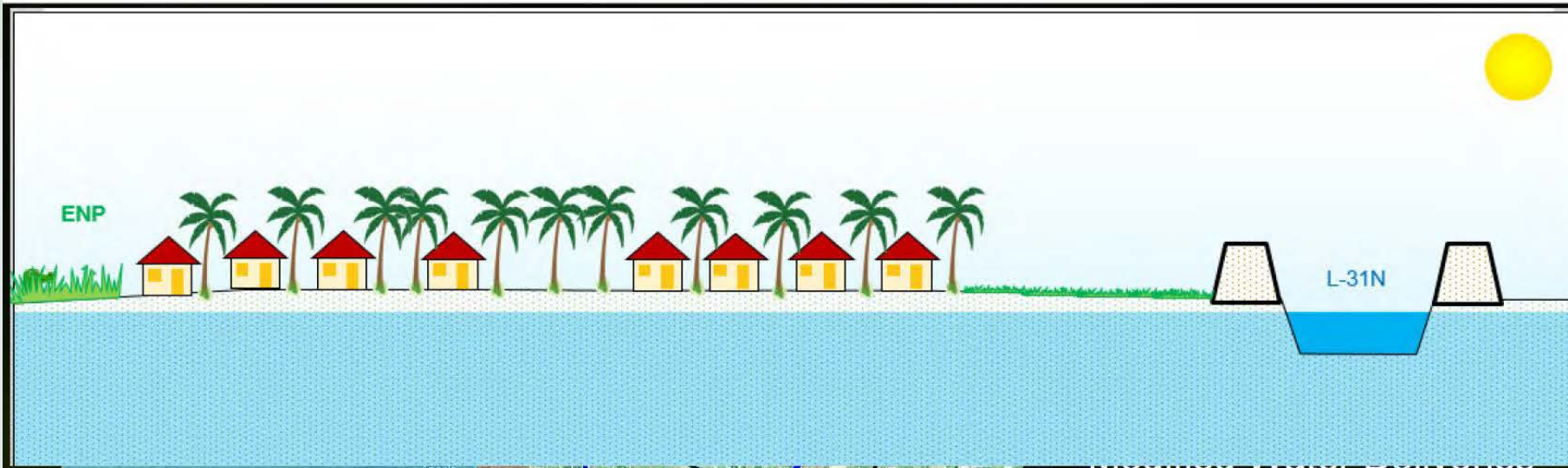

From Akintunde Owosina, PE, Bureau Chief Hydrology and Hydraulics SFWMD, Presentation Consideration on Moving Water to Shark River Slough 11/14/2019

THE PROBLEM



L-357W Levee



ENP Side



Residential Side

DESIGN PROCESS – GEOTECHNICAL EXPLORATION

- 55 borings - 70 feet in depth
- 5-foot core barrel, with 4" diameter cores retrieved for thirty-two (32) locations and for twenty-seven (27) locations, approximately 2" diameter cores
- (28) boring locations were used for geophysical testing
- Five (5) locations had single-depth monitoring wells installed following geophysical testing.

- Stratum 1: GRAVELLY SAND (EMBANKMENT/LEVEE FILL) – borings were advanced through unconsolidated materials to the top of consolidated limestone materials.
- Stratum 2: VERY SOFT TO VERY HARD LIMESTONE INTERBEDDED WITH SAND, SHELL AND SILT: Gray to light gray, brownish gray, to white limestone interbedded with varying thicknesses of sand and silt representative of the Miami Limestone and Fort Thompson Formations.
- Stratum 3: SAND WITH SHELL; PARTIALLY CEMENTED SANDSTONE WITH SHELL: light to dark brown, light gray sand with clay representative of the Tamiami Formation.



DESIGN PROCESS – GEOTECHNICAL EXPLORATION

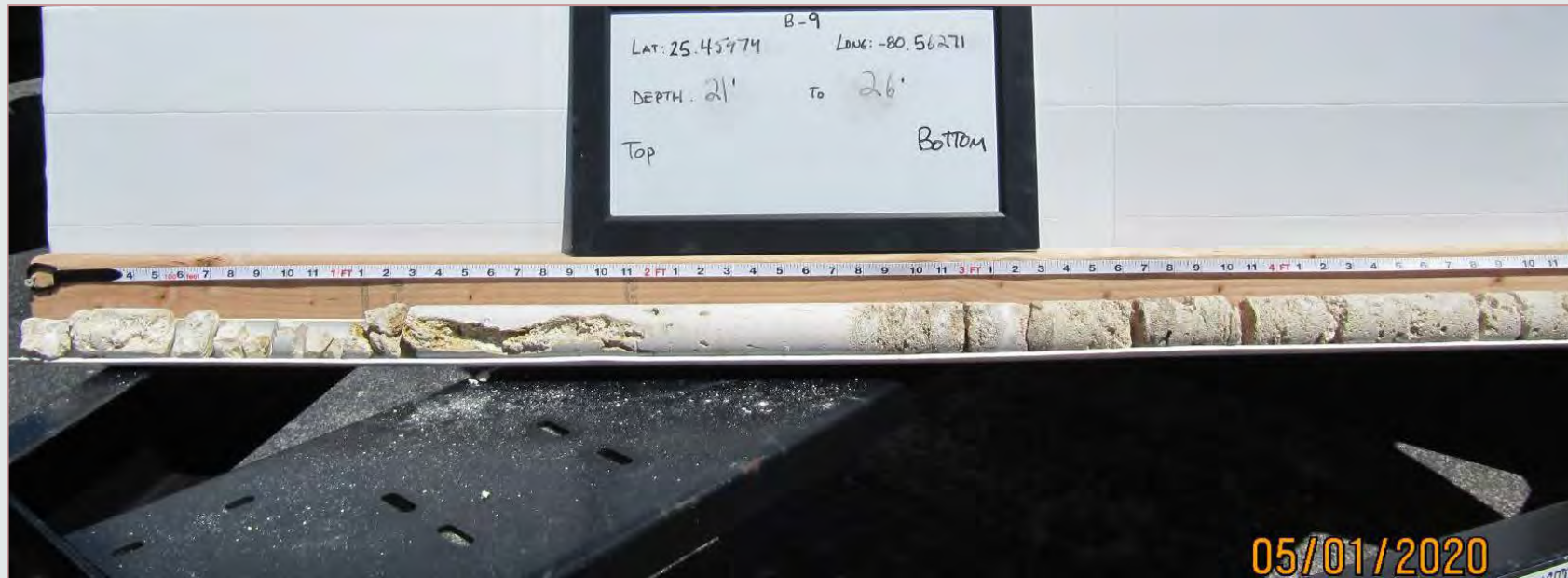
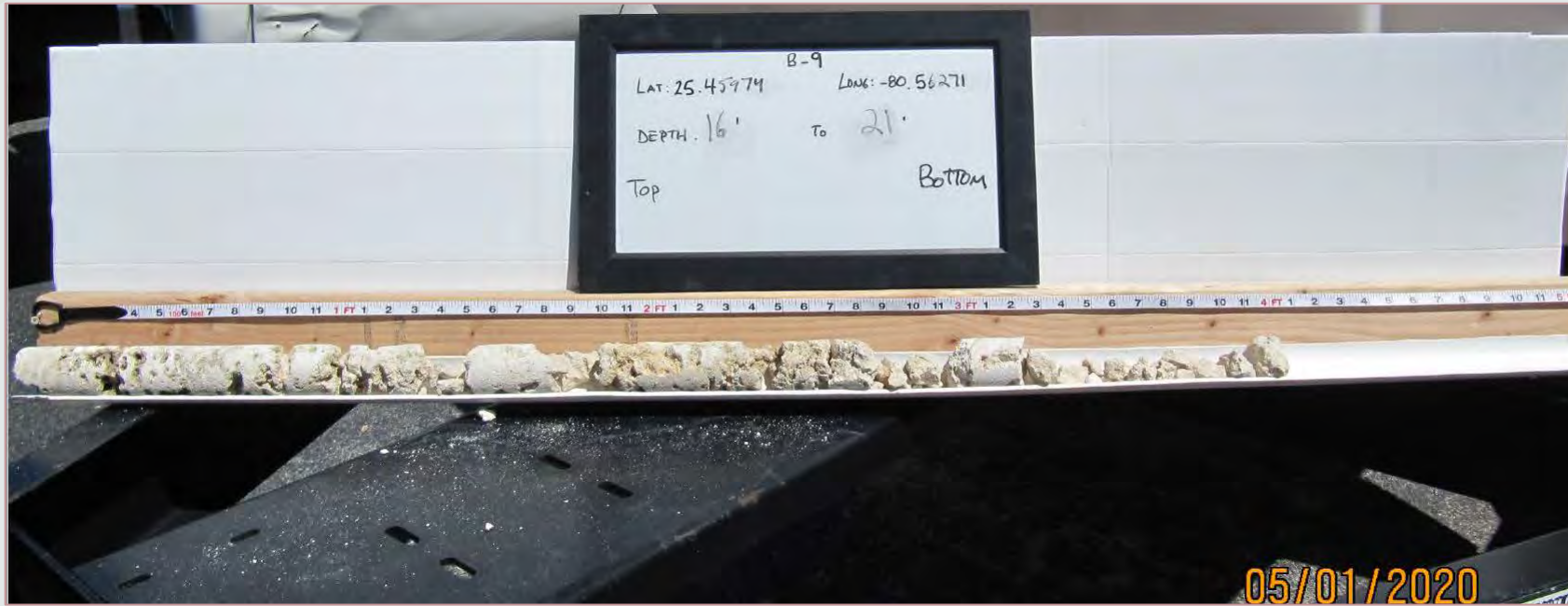

DESIGN PROCESS – GEOTECHNICAL EXPLORATION

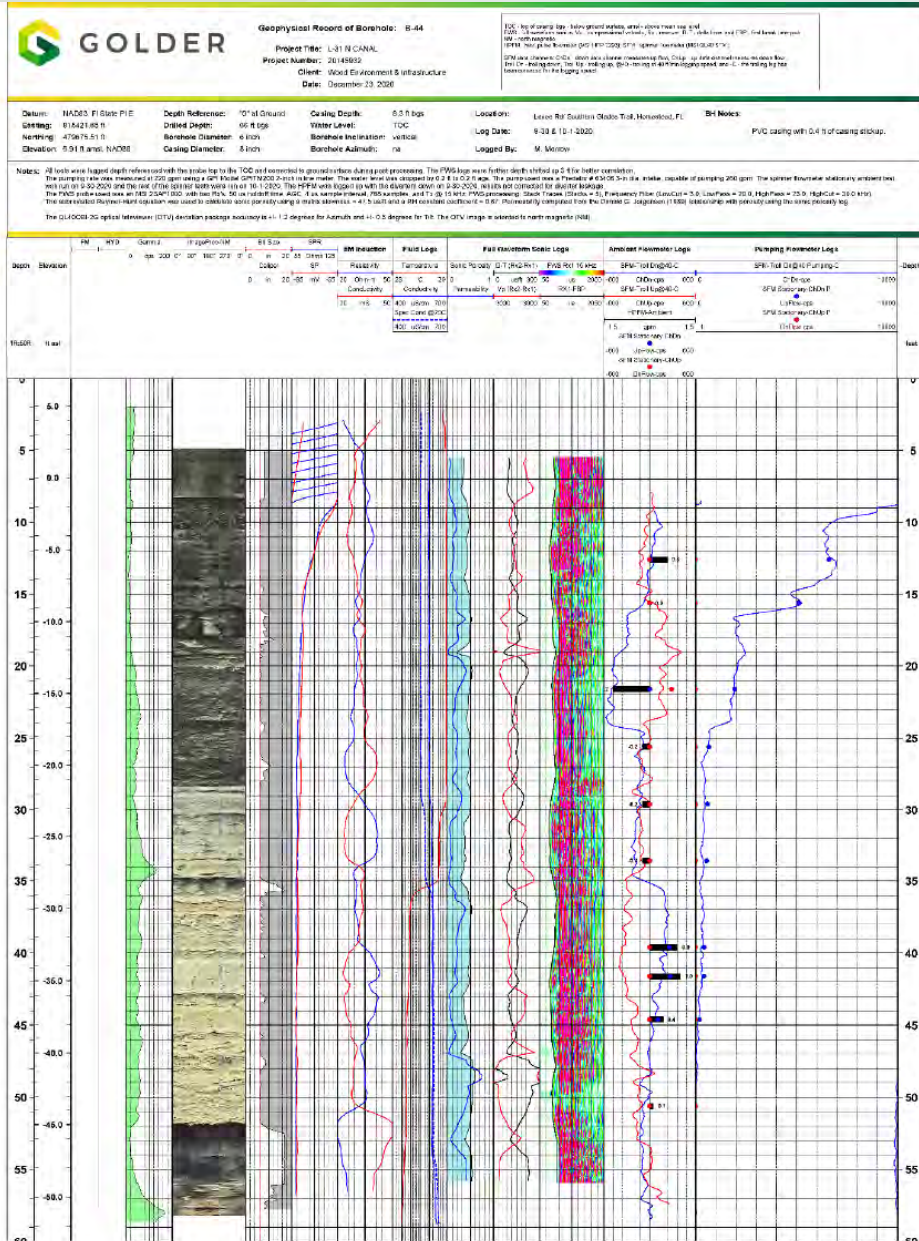

Figure 2. Example of borehole geophysical logs collected from B-44 along the L-31N Canal.

Geophysical logging includes:

- A.) electromagnetic induction resistivity and conductivity (EM)
- B.) natural gamma ray (GR)
- C.) spontaneous potential (SP)
- D.) single-point resistivity (SPR)
- E.) caliper
 - a. temperature
 - b. fluid conductivity
 - c. fluid resistivity
- G.) full waveform sonic (SONIC)
- H.) optical digital borehole image logs (OBI)
- I.) flow meters (FM)
 - a. heat pulse (HPFM)
 - b. spinner flow meter (SFM)
- J.) pH
- K.) dissolved oxygen
- L.) redox (WQ2)
- M.) acoustic borehole image logs (ABI)

DESIGN PROCESS – GEOTECHNICAL EXPLORATION

Hydraulic Conductivity (Kh) ranking estimates

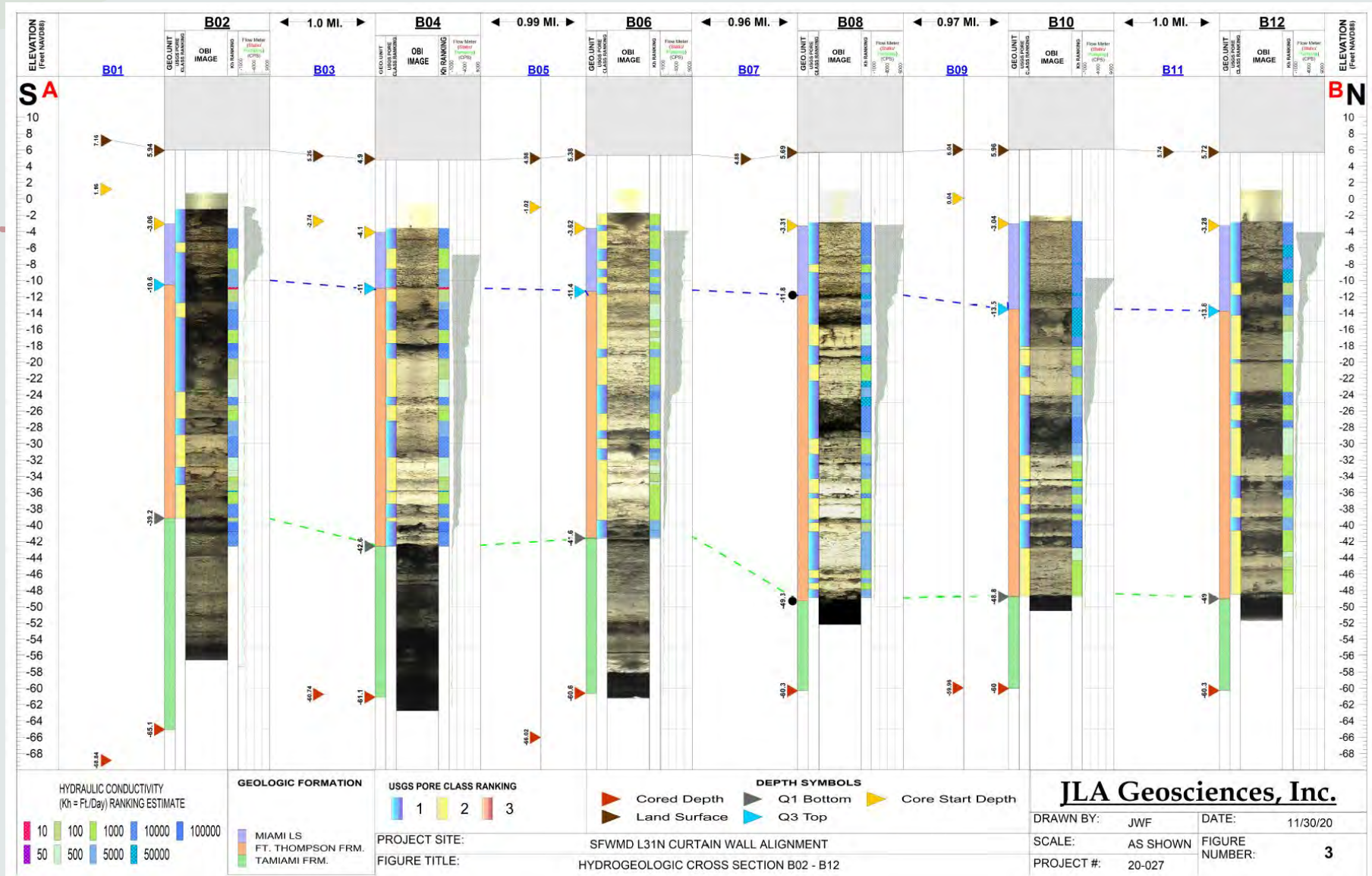

summary report provides cross sections depicting the various lithologic, geophysical, and hydrogeologic data and interpretations.

JLA estimated transmissivity values range from approximately 105,300 to 1,047,100 ft²/day.

DESIGN PROCESS – HYDROGEOLOGIC MODELING

Purpose - The modeling evaluation considers the effectiveness of constructing a seepage barrier at different depths to allow water levels to increase in ENP without negatively impacting the 8.5 SMA.

- Computer model was created utilizing the MODFLOW program developed by the USGS.
- The period 2016 - 2018 was simulated with specific emphasis on the very wet summer and fall of 2017.

Table 1. Model Layering and Hydraulic Conductivity

Model Layer	Bottom Elevation (ft-NGVD)	Thickness (ft)	Note	Horizontal Conductivity (ft/d)	Vertical Conductivity (ft/d)
1	Land Surface	NA	Wetland Layer	2.0E+07	2.0E+06
2	5	Variable	Muck/Fill Layer	150	150
3	-5	10	Flow Zone 1 (Miami Limestone)	12,500	1,250
4	-7	2	Hard Layer 1 (Q4)	50	50
5	-9	2	Flow Zone 2 (Upper Ft. Thompson)	25,000	2,500
6	-17	8	Flow Zone 2 (Upper Ft. Thompson)	25,000	2,500
7	-19	2	Hard Layer 2 (Q3)	50	50
8	-27	8	Flow Zone 3 (Middle Ft. Thompson)	25,000	2,500
9	-29	2	Hard Layer 3 (Q2)	50	50
10	-47	18	Flow Zone 4 (Lower Ft. Thompson)	25,000	2,500
11	-97	50	Tamiami Formation Upper Confining Unit	50	50

DESIGN PROCESS – HYDROGEOLOGIC MODELING



Calibration



DESIGN PROCESS – HYDROGEOLOGIC MODELING

Figure 8. Seepage Flowline Locations

- Flowline A is from the eastern terminus of the south leg of the wall to approximately one half mile further to the east
- Flowline B is from the eastern terminus of the south side of the wall to the southwestern corner of the wall near LPG1
- Flowline C is from the southwestern corner of the wall to the northwestern corner of the wall
- Flowline D is from the northwestern corner of the wall to the eastern terminus of the north leg of the wall
- Flowline E is from the eastern terminus of the north leg of the wall north approximately 1 mile

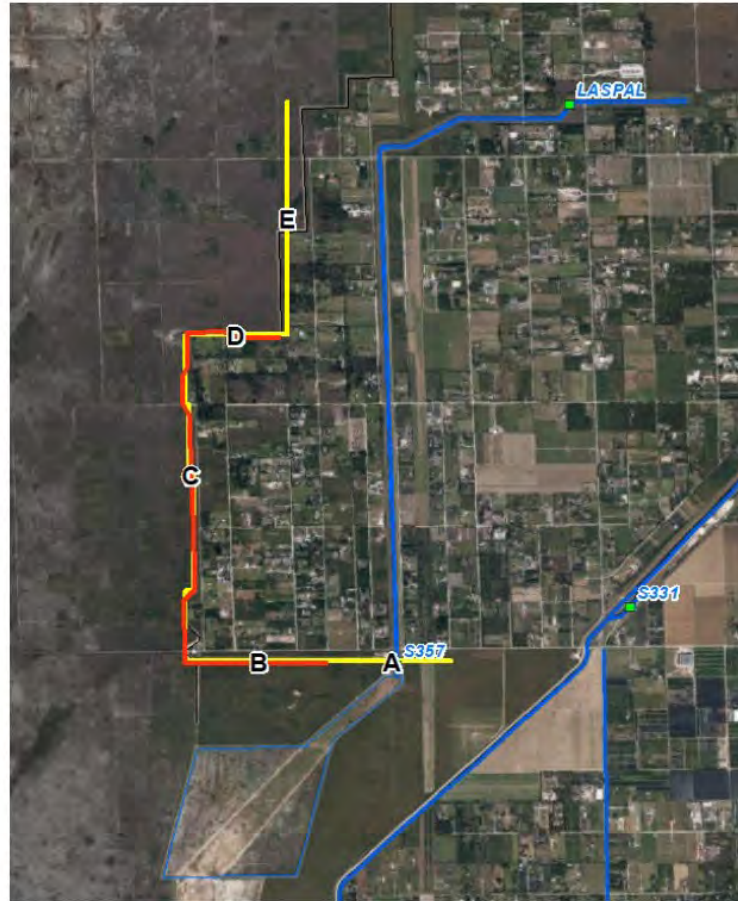

Flow Lines

A and **E** are path at the ends of the proposed (8.5 SMA segment) seepage wall.

DESIGN PROCESS – HYDROGEOLOGIC MODELING

Fourteen different model simulations were performed.

Table 4. Seepage Summary Table Blue text indicates a reduction in seepage into Las Palmas and red text indicates an increase.

Scenario	Seepage Across Flowlines into the Project Area (See Figure 8)										Conditions at LPG2	
	Seepage - October 2017 (acft/day)					Seepage reduction from Base - October 2017					Average Stage	Days Flooded
	A	B	C	D	E	A	B	C	D	E	Oct. 2017	2017
Base	141	201	164	35	155	relative to Base					7.26	152
Base_W7	149	160	148	32	155	-5%	20%	10%	7%	0%	7.13	150
Base_W9	151	140	140	34	158	-7%	30%	15%	2%	-2%	7.07	148
Base_W10	167	5	13	18	177	-18%	98%	92%	50%	-15%	4.38	5
Base13	133	193	156	37	147	relative to Base13					7.28	153
Base13_W10b	151	86	109	30	154	-13%	56%	30%	18%	-5%	6.77	142
						relative to Base13_W10b						
Base13_W10b_K10x0.5	129	60	84	25	131	14%	30%	23%	18%	15%	6.68	146
						relative to Base_W9						
Base_W9_K10x2	191	182	186	37	197	-26%	-30%	-33%	-7%	-24%	6.99	139
Base_W9_K10x0.5	129	108	112	30	132	15%	23%	20%	13%	16%	7.06	153
CEPP	199	459	309	95	209	relative to CEPP					8.10	246
CEPP_W9	212	206	205	62	231	-6%	55%	34%	34%	-11%	7.67	245
CEPP_W10	231	6	16	22	253	-16%	99%	95%	76%	-21%	4.85	44
CEPP13	190	446	301	93	200	relative to CEPP13					8.11	246
CEPP13_W10b	211	113	143	43	229	-11%	75%	53%	53%	-15%	7.33	243

Summary Seepage Reductions



LPG 2

DESIGN PROCESS – HYDROGEOLOGIC MODELING

Base_W10 – Seepage Barrier through Layer 10 - Simulation of the Seepage Barrier Results Barrier approximately 54 feet below land surface.

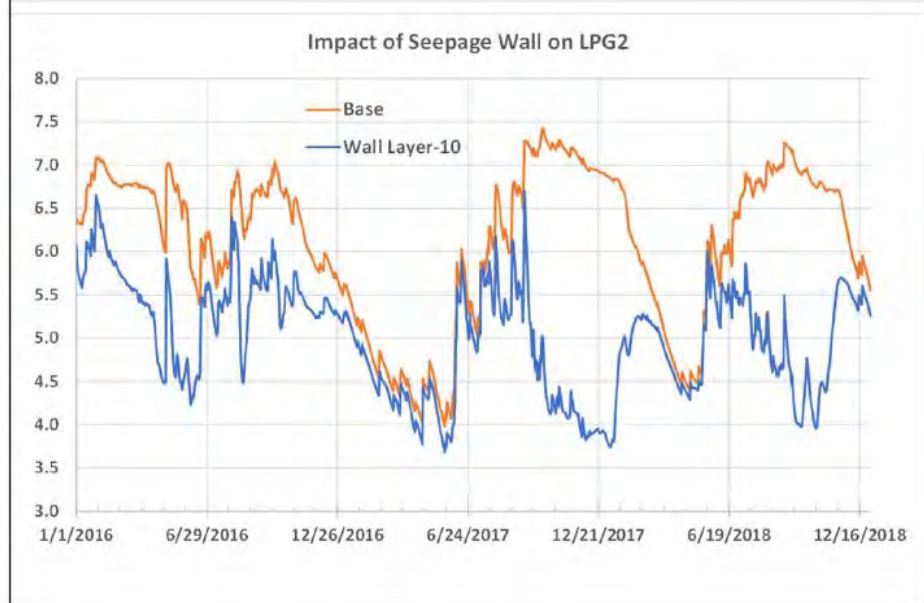
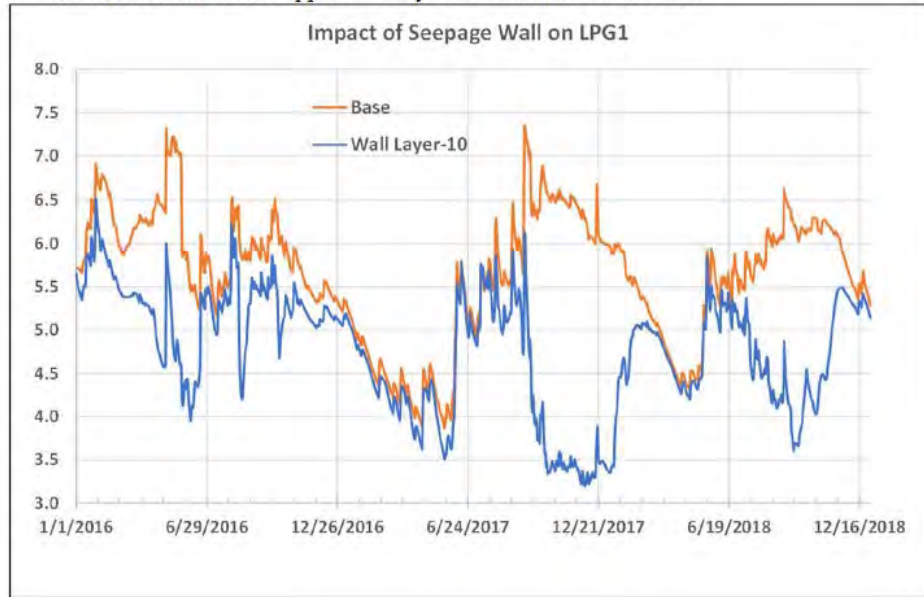

Seepage Barrier through Layer 10

DESIGN PROCESS – HYDROGEOLOGIC MODELING

CALIBRATED BASE

October 2017 Average Water Levels – Base (ft, NGVD)

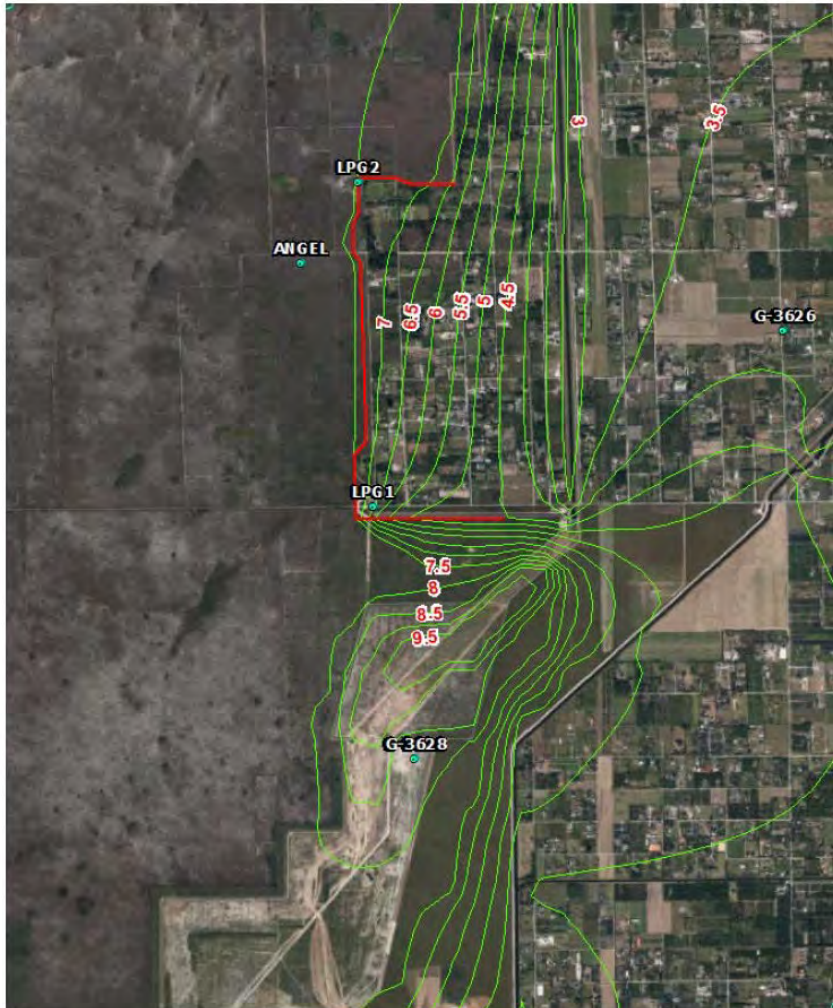

October 2017 Average Water Levels – Layer-10 Wall (ft, NGVD)

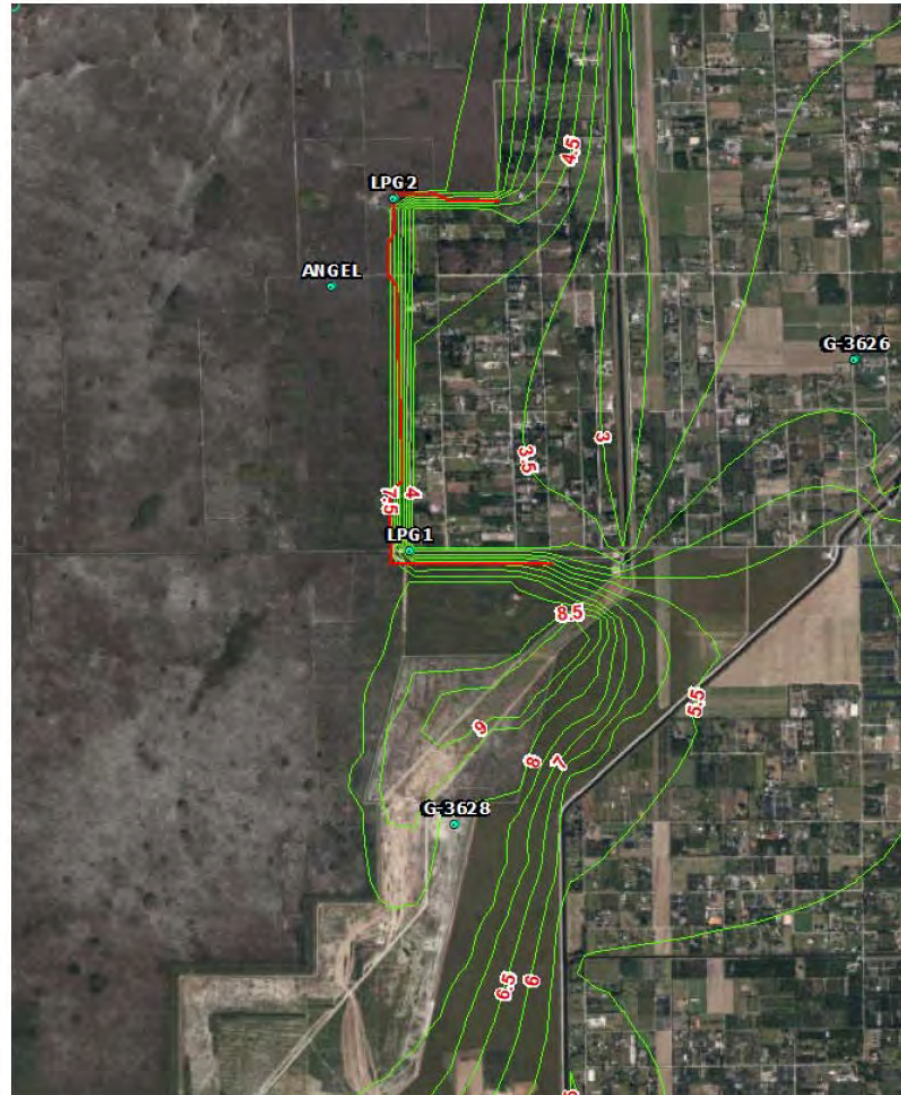

DESIGN PROCESS – CUTOFF WALL

From Wood's geotechnical report.

The cutoff wall is constructed by filling the trench with a mixture of **native soil and bentonite [Soil Bentonite (SB) wall]**, or **cement and bentonite [Cement Bentonite (CB) wall]**, or **soil, cement, and bentonite [(SCB) wall]**. For this application, with very little on-site soil available due to the limestone being close to ground surface, the CB wall is the best alternative. In addition, the rock has large voids and solution cavities, especially in the high flow zones, and the cement in the backfill mix will penetrate these voids and plug them as the cement sets up.

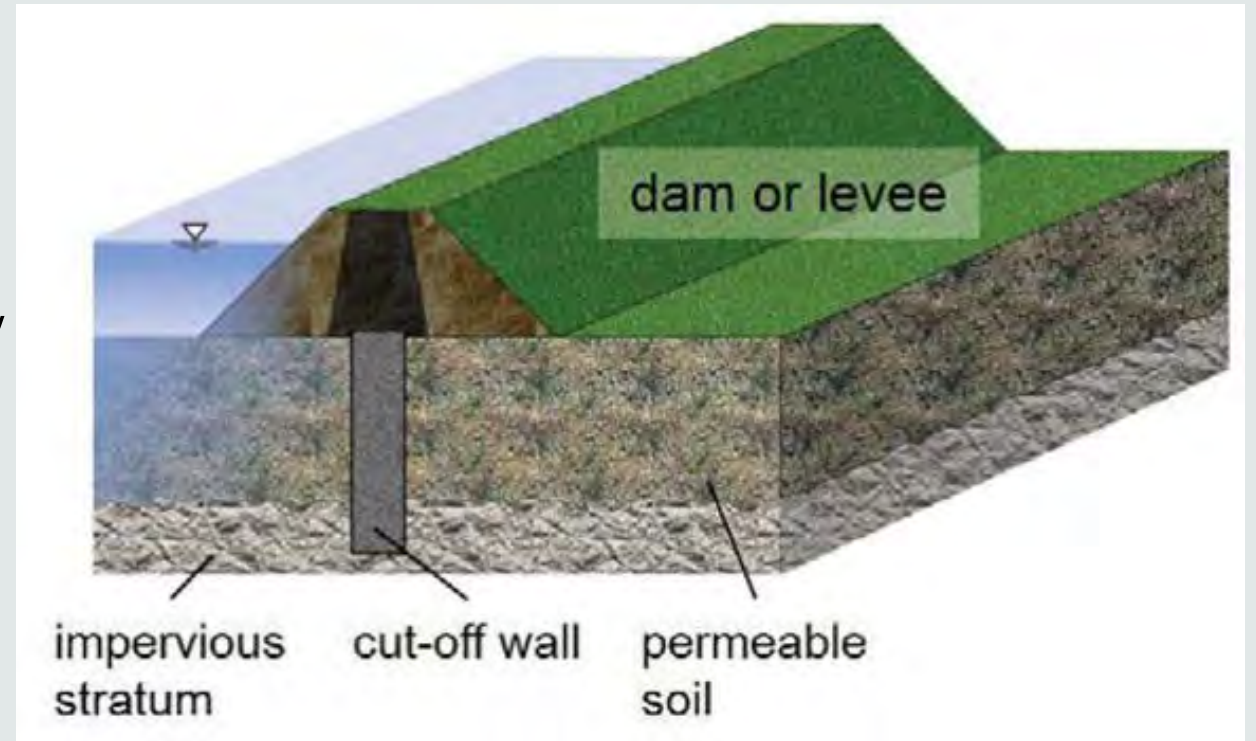

<https://www.degruyter.com/document/doi/10.1515/eng-2019-0050/html>

DESIGN PROCESS - PLANS

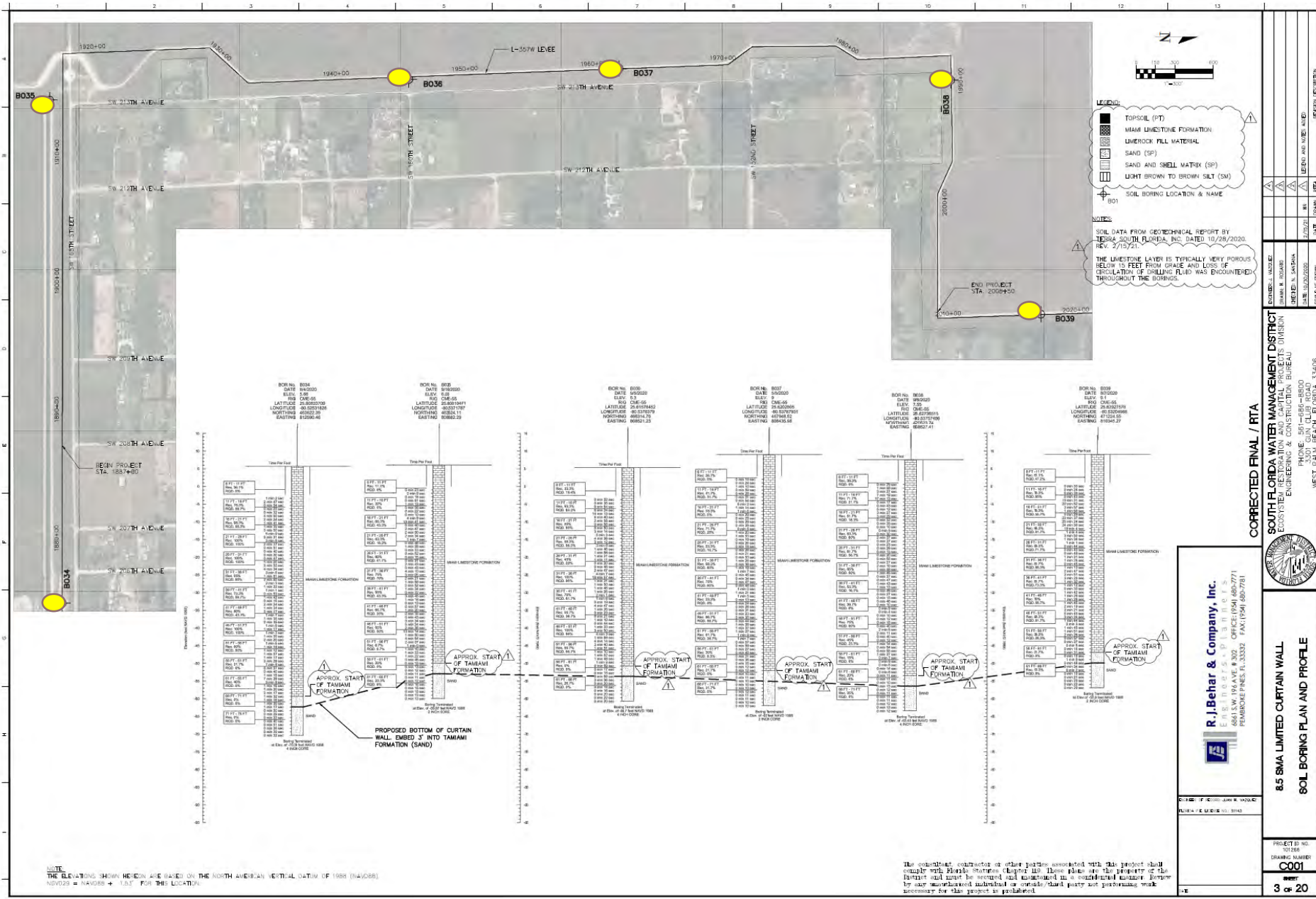

3-foot penetration into the Tamiami Formation

R. J. Behar & Company, Inc.
 ENGINEERS • PLANNERS
 6861 S.W. 196 AVE. # 302 OFFICE (954) 687-7771
 FORTLAUDERDALE, FL 33309 FAX (954) 687-7781

**8.5 SMA LIMITED CURTAIN WALL
 SOIL BORING PLAN AND PROFILE**

PROJECT NO. 100268
 DRAWING NUMBER C001
 SHEET 3 OF 20

DESIGN PROCESS - PLANS

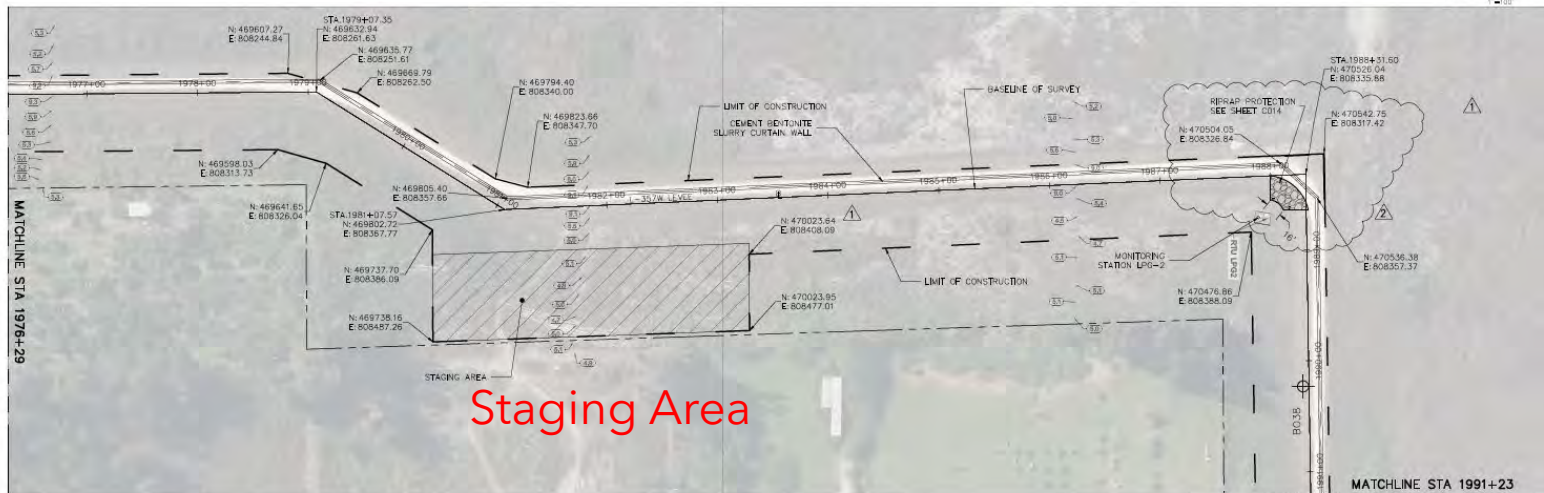
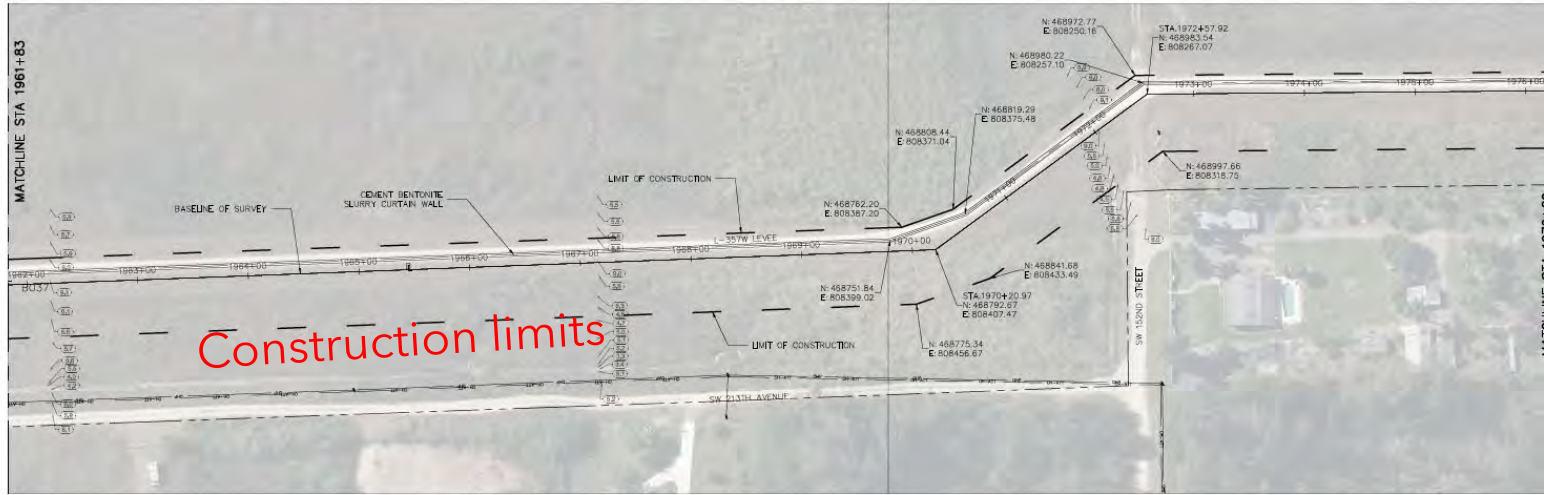

NOTE: THE ELEVATIONS SHOWN HEREIN ARE BASED ON THE NORTH AMERICAN VERTICAL DATUM OF 1988 (NAVD88).
 NAVD83 = NAVD88 + 1.15' FOR THIS LOCATION

The consultant, contractor or other parties associated with this product shall comply with Florida Statutes, Chapter 489. These plans are the property of the Engineer and shall not be copied, reproduced, or otherwise used without the written consent of the Engineer. No part of these plans shall be used for any other project without the written consent of the Engineer.

R.J.Behar & Company, Inc.
 ENGINEERS - PLANNERS
 6843 S.W. 19th AVE. # 302 OFFICE (954) 680-7771
 PEMBROKE PINES, FL 33032 FAX: (954) 680-7781

CORRECTED FINAL / R/A

SOUTH FLORIDA WATER MANAGEMENT DISTRICT
 ECOSYSTEMS DIVISION
 ENGINEERING & CONSTRUCTION BUREAU
 PHONE: 561-688-8800
 3301 SUN CLUB ROAD
 WEST PALM BEACH, FLORIDA 33406

8.5 SMA LIMITED CURTAIN WALL
 CURTAIN WALL PLAN (4 OF 5)

PROJECT ID NO:
 101286
 DRAWING NUMBER:
0006
 8 of 20

- Define alignment
- Define Construction limits
- Define/estimate staging areas

DESIGN PROCESS - PLANS

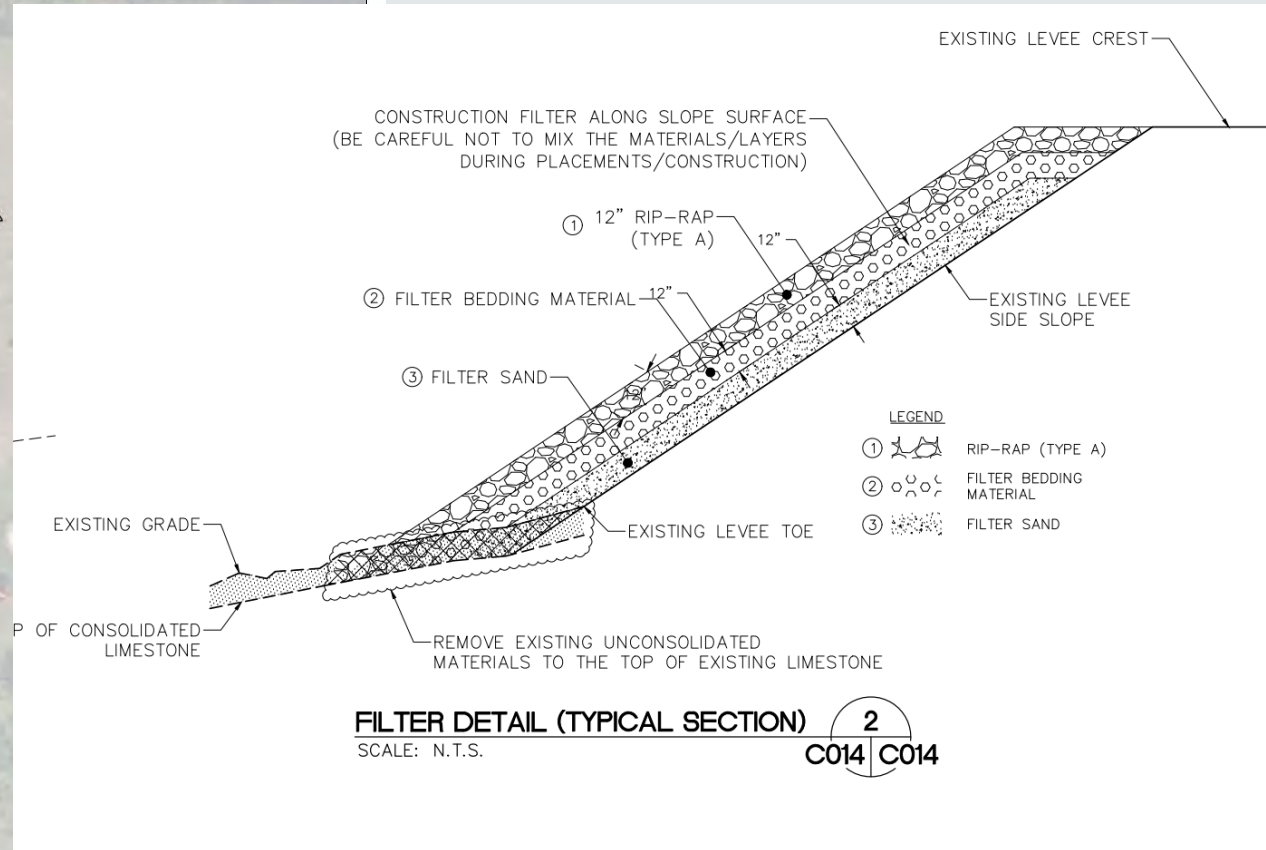
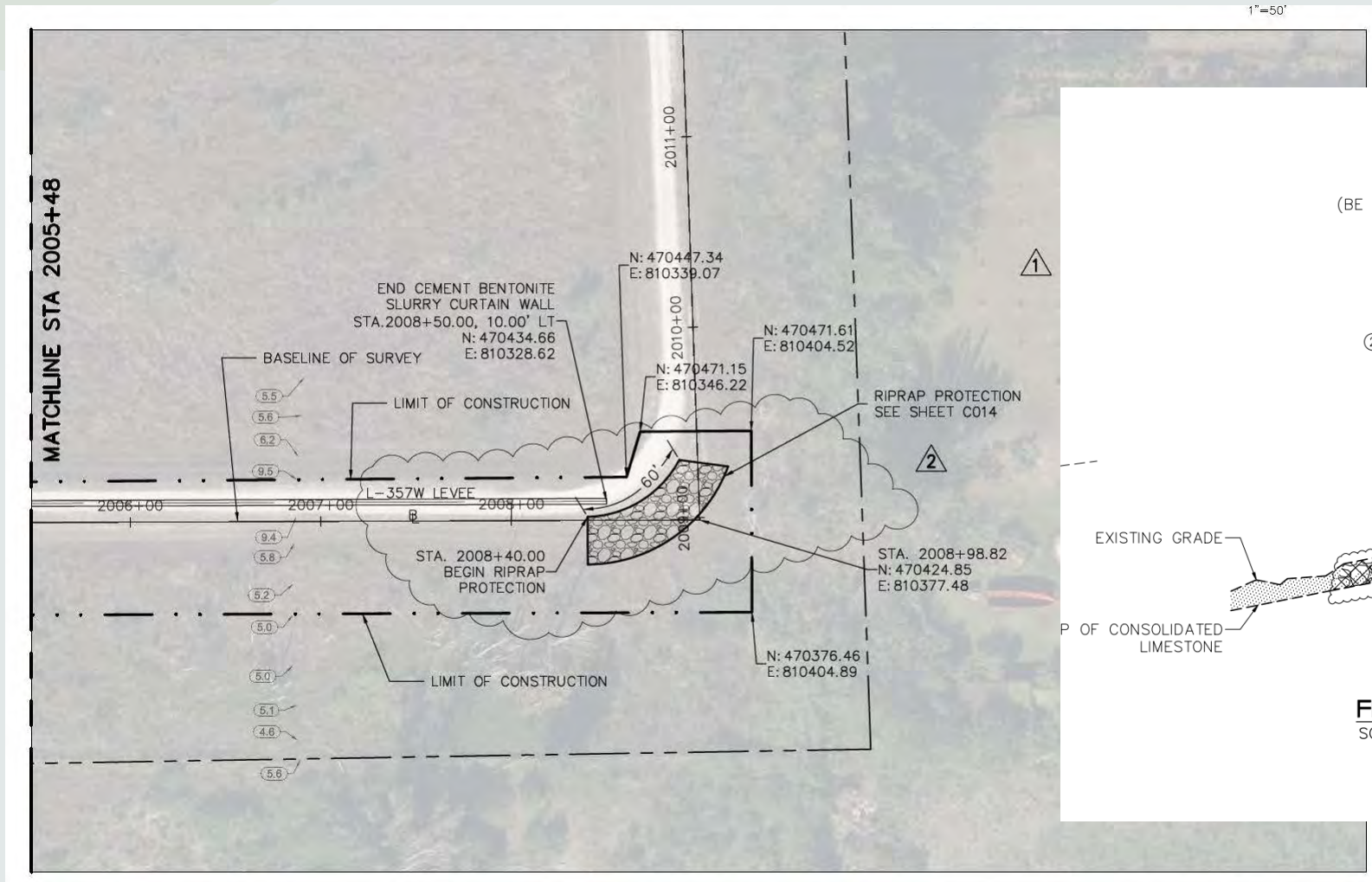

Reference: Design and Construction of Levees, EM 1110-2-1913, Department of the Army, U.S. Army Corps of Engineers, 30 April 2000. Appendix D

DESIGN PROCESS - PLANS

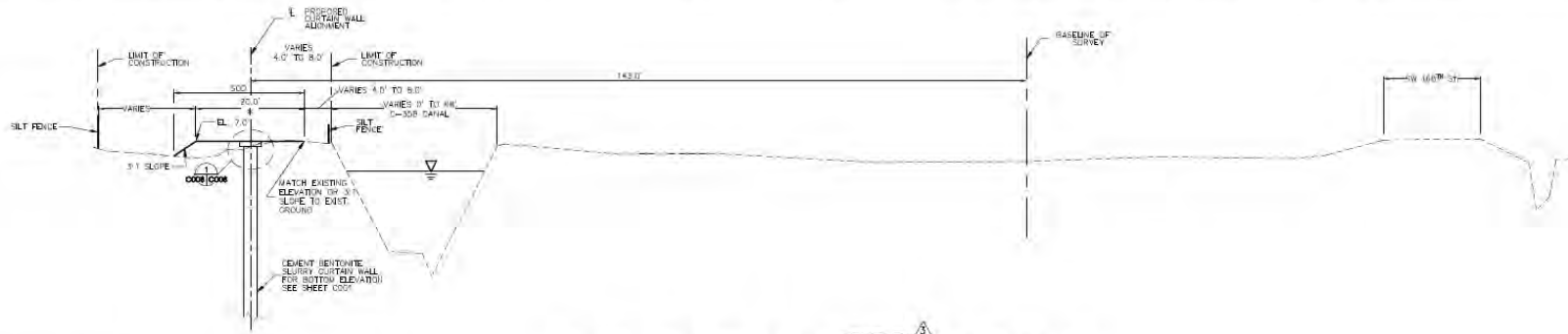

TYPICAL SECTION - STA. 1887+00 TO 1913+63 (BASELINE OF SURVEY)
SCALE: 1" = 10'

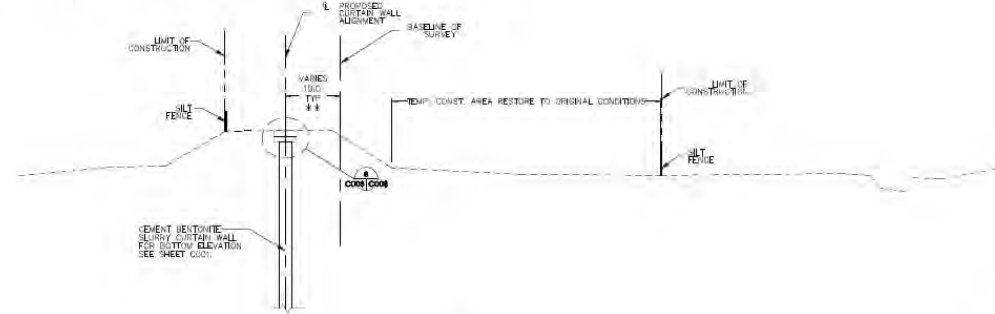

TYPICAL SECTION - STA. 1920+50 TO 2008+50 (BASELINE OF SURVEY)
SCALE: 1" = 10'

8'-6" FROM 1920+50 TO 2008+50

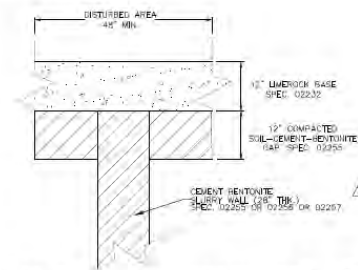

WALL COMPLETION DETAIL THROUGH LEVEE
SCALE: N.T.S.

PERMANENT EMBANKMENT (SELECT FILL)
FOR TEST SECTION SEE SHEET C014.

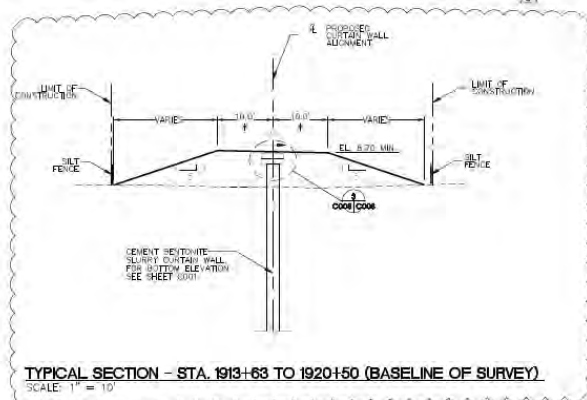

TYPICAL SECTION - STA. 1913+63 TO 1920+50 (BASELINE OF SURVEY)
SCALE: 1" = 10'

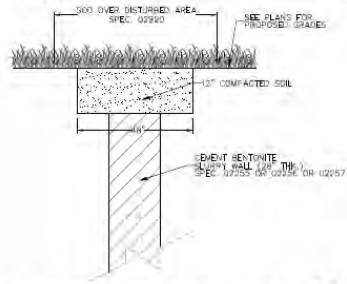

WALL COMPLETION DETAIL GRASS AREAS
SCALE: N.T.S.

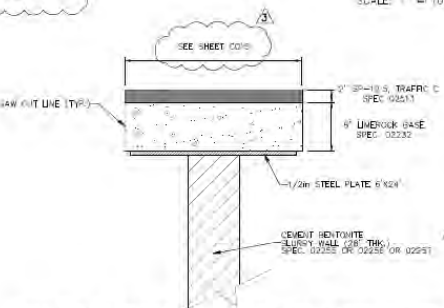

WALL COMPLETION DETAIL UNDER ASPHALT PAVEMENT
SCALE: N.T.S.

NO.	DATE	BY	CHKD.	DESCRIPTION
1	07/20/20	AS	AS	ISSUE FOR PERMITS
2	07/20/20	AS	AS	REVISED
3	07/20/20	AS	AS	REVISED
4	07/20/20	AS	AS	REVISED

CORRECTED FINAL / RTA
SOUTH FLORIDA WATER MANAGEMENT DISTRICT
 2000 W. WINDY HILL BLVD., SUITE 100
 WEST PALM BEACH, FLORIDA 33411
 PHONE: 561-838-8800
 3307 CANAL CLUB ROAD
 WEST PALM BEACH, FLORIDA 33409



R.J. Behar & Company, Inc.
 1001 S.W. 10th Ave., Suite 1000
 Ft. Lauderdale, FL 33304
 PHONE: (954) 460-7771
 FAX: (954) 460-7881
 FT. LAUDERDALE OFFICE: (954) 460-7771
 WEST PALM BEACH OFFICE: (561) 838-8800

8.5 SMA LIMITED CURTAIN WALL
SEEPAGE WALL TYPICAL SECTIONS



ALWAYS CALL 811. Even if it has been days before you dig to have underground utilities located and marked.
Sunshine 811.com
 THE ELEVATIONS SHOWN HEREIN ARE BASED ON THE NORTH AMERICAN VERTICAL DATUM OF 1988 (NAVD83). PROJECTIONS = NAD83 + 1102' FOR THIS LOCATION.
 THE CONSULTANT CONTRACTOR OR OTHER PARTY ASSOCIATED WITH THIS PROJECT SHALL VERIFY THE FIELD CONDITIONS SHOWN HEREIN BEFORE PLACING ANYTHING IN THE GROUND. THE CONTRACTOR SHALL BE RESPONSIBLE FOR OBTAINING ALL NECESSARY PERMITS AND FOR THE PROTECTION OF ALL UTILITIES AND STRUCTURES. THE CONTRACTOR SHALL BE RESPONSIBLE FOR OBTAINING ALL NECESSARY PERMITS AND FOR THE PROTECTION OF ALL UTILITIES AND STRUCTURES. THE CONTRACTOR SHALL BE RESPONSIBLE FOR OBTAINING ALL NECESSARY PERMITS AND FOR THE PROTECTION OF ALL UTILITIES AND STRUCTURES.



PROJECT NO. 19-001
 DRAWING NUMBER
C008
 SHEET
10 OF **20**

DESIGN PROCESS

PART 1 - GENERAL

1. SCOPE:

Summary of Work: The CONTRACTOR shall furnish all labor, materials, and equipment for the construction of Cement-Bentonite Wall (CB Wall) as shown on the Drawings or as specified herein. The CB Wall shall be constructed at the location showing in the Plans, and from a foundation grade determined by the CONTRACTOR to provide trench stability and reach the bottom elevation of the wall shown on the drawings. Soil boring profiles are provided on the Drawings, as well as in the Design Geotechnical Report.

2. APPLICABLE STANDARDS AND REFERENCES

ASTM INTERNATIONAL

ASTM C 150	Standard Specification for Portland Cement
ASTM D1633	Standard Test Methods for Compressive Strength of Molded Soil-Cement Cylinders
ASTM D4380-84(2006)	Standard Test Method for Density of Bentonitic Slurries
ASTM D-4832-16e1	Standard Test Method for Preparation and Testing of Controlled Low Strength Material (CLSM) Test Cylinders
ASTM D5084-03	Standard Test Methods for Measurement of Hydraulic Conductivity of Saturated Porous Materials Using a Flexible Wall Permeameter
ASTM D698	Standard Test Methods for Laboratory Compaction Characteristics of Soil Using Standard Effort

AMERICAN PETROLEUM INSTITUTE (API)

API RP 13B-1	Recommended Practice for Testing Water-Based Drilling Fluids
API Spec 13A	Specification for Drilling Fluid Materials

2. DEFINITIONS

- A. Cement Bentonite Wall (CB Wall):** The Cement-Bentonite (CB) Wall consists of a vertical trench filled with a specified viscous fluid mixture of Portland cement and Bentonite clay as shown on the plans and in the Specifications. The CB Wall is a minimum twenty-eight (28) inches thick curtain of low permeability material. The trench will be excavated through the prepared foundation grade to the specified bottom elevation using a method proposed by the CONTRACTOR and approved by the DISTRICT. The CB wall construction involves placement of CB slurry into the trench to approximately foundation grade, as shown in the project drawings and described in this specification. The cured Cement Bentonite will form the CB low permeability wall in the desired location.
- H. Proof of Concept:** Demonstration by CONTRACTOR that means and methods utilized will accomplish the intended goals of the project, meet the quality control aspects of the project, and establish protocols for survey controls, communication of schedule, inspections, and documentation of the work. Proof of Concept for the CB Wall shall successfully demonstrate all aspects of the CB Wall construction, including the Working Pad, and CB Wall. The first 500-feet of the wall may be utilized for the Proof of Concept.

Table 1: Cement - Bentonite Slurry Trench Quality Control Testing Plan

Property	Requirement	Minimum Test	Test Method	Comment
		Frequency		
Bentonite Powder				
a. Certification	By Manufacturer	1 per shipment	API 13A	Wyoming type (90 bbl/ton)
Cement Powder				
a. Certification	By Manufacturer	1 per shipment	ASTM C 150 ASTM C 989	Portland Type I or I-II Performed weekly during slurry production
Water for Slurry Mixing				
a. pH	6 to 9	1 per week	Hach Kit	Site Source
b. Hardness	< 250 ppm	1 per week	Hach Kit	
c. Alkalinity	< 250 ppm	1 per week	Hach Kit	
d. Total Dissolved Solids	< 1500 ppm	1 per source	Hach Kit	
c. Permeability	< 9 x 10 ⁻⁶ cm/sec	1 set per 200 lf, per each sample depth interval.	ASTM D5084	Based on 28-days of curing Each set consists of 8 samples (4 out of the 8 samples to be provided on site to the District for QA testing)

< 9 x 10⁻⁶ cm/sec

DESIGN PROCESS

Federal Permits:

- USACE Section 404 - Impacts to wetlands
- USACE Section 408 - to alter the Central & Southern Florida (C&SF) Flood Control Project

State Permits:

- Modification of the Comprehensive Everglades Restoration Plan Regulation Act (CERPRA) under 373.1502 F.S.
- FDEP NPDES Construction Generic Permit (CGP)
- SFWMD Dewatering Permit

Local Permits (Miami-Dade County)

- Blasting Permit
- MOT for any temporary street closings

CONSTRUCTION - SUBMITTALS

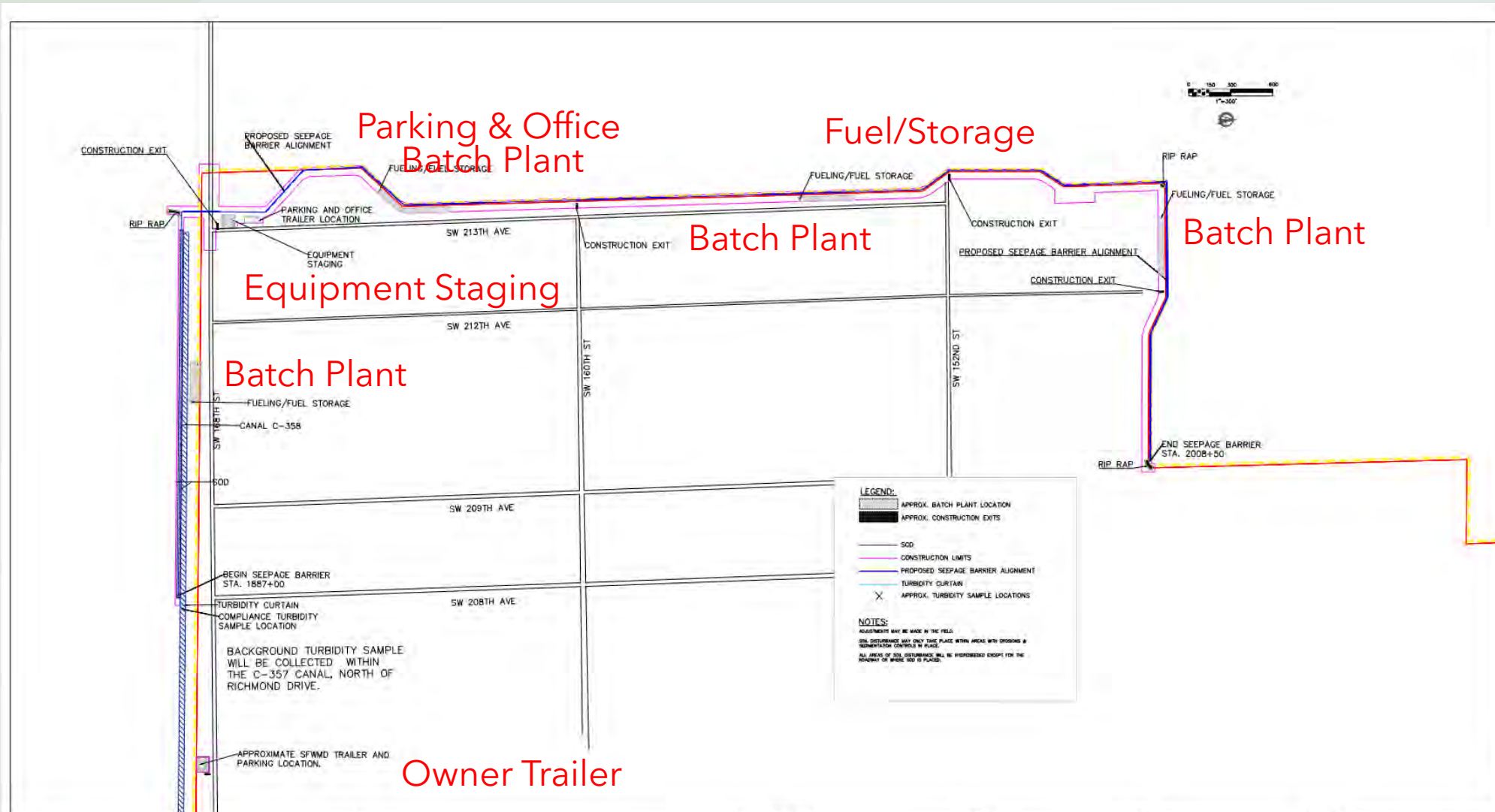

8.5 SQUARE MILE AREA (SMA)
LIMITED CURTAIN WALL

MIAMI, FL

GEO-SOLUTIONS PROJECT # 20-216

DRAWN BY	
CHECKED	
APPROVED	

SEAL

PROPERTY OF GEO-SOLUTIONS, INC.
IMPORTANT: THIS DRAWING PRINT IS LOANED FOR MUTUAL ASSISTANCE AND AS SUCH IS SUBJECT TO RECALL AT ANY TIME. INFORMATION CONTAINED HEREON IS NOT TO BE DISCLOSED OR REPRODUCED IN ANY FORM FOR THE BENEFIT OF PARTIES OTHER THAN NECESSARY SUBCONTRACTORS AND SUPPLIERS WITHOUT THE WRITTEN CONSENT OF GEO-SOLUTIONS, INC.

6/24/2021
DATE

REVISIONS		
REV	DESCRIPTION	
(A)	Reviewed	Checked
(B)	Reviewed	Checked
(C)	Reviewed	Checked

SHEET 1 OF 1

Drawing Name
20-216 SITE LAYOUT

CONSTRUCTION – STAGING AREAS



CONSTRUCTION – PROOF OF CONCEPT



CONSTRUCTION



1250 Fifth Avenue
New Kensington, PA 15068
Tel: 724-335-7273
Fax: 724-335-7271

BENTONITE

A sample of premium grade powdered bentonite was obtained from Cetco located in Lovell, WY. This bentonite complies with American Petroleum Institute 13A, Section 9 requirements.

CEMENT

The cement used for the laboratory design mix was a standard Portland Type I/II powdered cement provided by Lehigh Hanson.

3.0 SAMPLE PREPARATION

BENTONITE SLURRY MIXING

The bentonite slurry mixtures were made using Saint Petersburg, FL tap water, and the premium grade powdered bentonite. The bentonite slurry mixtures were prepared using a high-speed mixer until the bentonite and water were fully mixed. Tests conducted on bentonite slurry were viscosity and density.

MEASURING VISCOSITY AND DENSITY

The results of the bentonite slurry tests are as follows:

Mix #	B/W Ratio	Marsh Funnel Viscosity	Density
2	6.53 %	34.4 sec	65.0 pcf
3	5.89%	33.7 sec	65.0 pcf
4	6.49%	34.0 sec	65.0 pcf

CEMENT-BENTONITE SLURRY MIXING

The hydrated bentonite slurry was then used to make the CB slurry mixes. Cement was added and mixed with the high speed mixer until the mix was homogeneous.

MIXING AND TESTING CB SLURRY

The results of the CB slurry tests are as follows:

Mix #	B/W Ratio	C/W Ratio	Density
2	6.53%	20.01%	72.0 pcf
3	5.89%	18.00%	71.5 pcf
4	6.49%	22.04%	73.25 pcf



1250 Fifth Avenue
New Kensington, PA 15068
Tel: 724-335-7273
Fax: 724-335-7271

4.0 CURED CB SAMPLE RESULTS

The molded samples were capped and cured. For mixes #2, 3 & 4 UCS and permeability were tested at 14, 21, and 28 days. The results of the laboratory testing are as follows:

MIX #	UCS (psi)			Permeability (cm/sec)		
	14 day	21 day	28 day	14 day	21 day	28 day
-						
2	3.2	11.6	9.1	7.47E-05	7.47E-06	6.38E-06
3	5.6	5.7	6.2	1.35E-05	2.97E-05	2.68E-05
4	13.7	14.6	18.5	1.00E-05	7.49E-06	8.64E-06

5.0 CONCLUSION/RECOMMENDATION

Based on the results of this program and our previous data from working in this area, a CB slurry mix with increased bentonite and cement will meet the requirements for the completed wall.

As indicated by the lab data, additional bentonite in the CB slurry will provide better permeability results, and more cement will provide higher strengths. It is our intention to begin the barrier wall installation in the field using mix #4 and adjust, based on lab results, to achieve the project objectives.

CONSTRUCTION - DRILLING



CONSTRUCTION - BLASTING



LPG2

Loaded blast holes

CONSTRUCTION - BLASTING

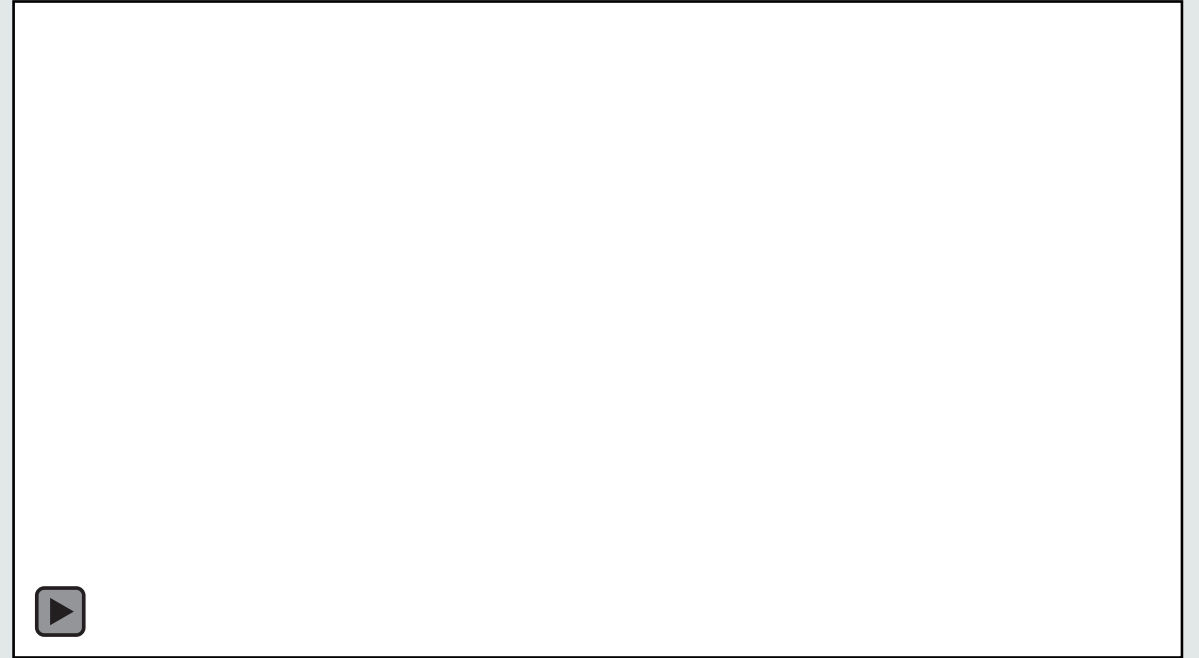
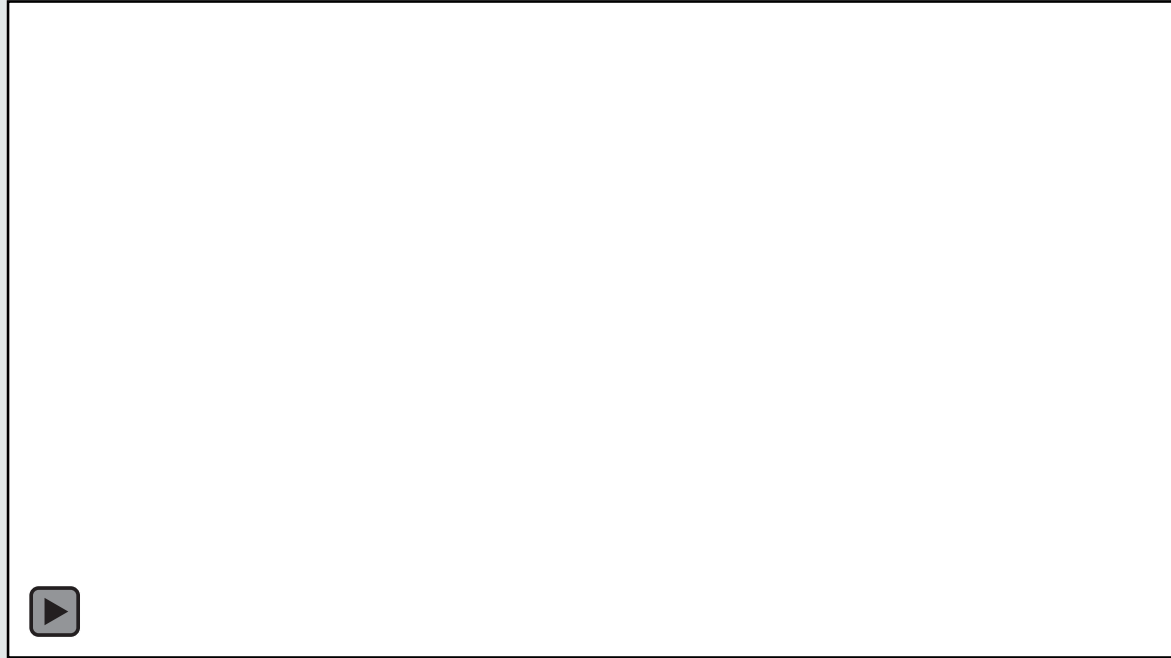

CONSTRUCTION - TRENCHING



CONSTRUCTION - TRENCHING



Feb 14, 2022 10:54:29 AM
14750 SW 212th Ave, Miami, FL 33196, USA

Trencor 1860HDE Specifications

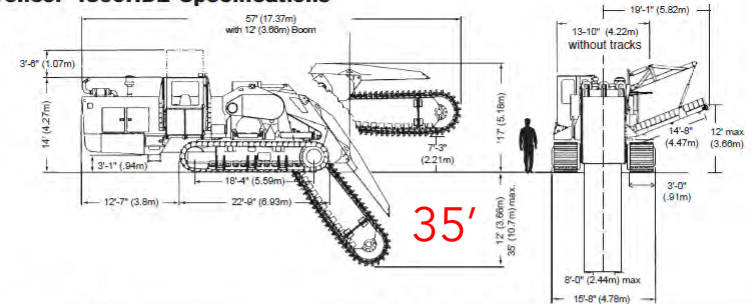

POWER UNIT

Caterpillar® model 3512 diesel engine, rated 1200hp (895kW) @ 1800 rpm is used to power the digging chain only. A Caterpillar® model C9 engine, rated at 300 hp (224 kW) @ 2100 rpm is used for all other functions. Both engines are equipped with two stage air cleaner systems, 24-volt electric starters, cooling system for 120 degree (55°C) ambient temperature operation, and mufflers.

DIGGING ASSEMBLY DRIVE

An extra heavy-duty headshaft is driven from both sides by a two-stage roller chain arrangement, a heavy-duty differential and a four speed power shift transmission with an integral three element torque converter. All shafts, chains and bearings are designed to withstand the full output of the torque converter and transmission in the stall condition. All drive chains are fully enclosed and oil bath lubricated. Chain tension in each chaincase is adjustable by eccentric hubs.

DIGGING CAPACITY

Boom lengths from 10 through 35 ft (3.05 - 10.7 m) with widths from 36 through 96 inches (91 - 2.44 m). Width and depth maximums are subject to approval.

DIGGING CHAIN

D-8 Caterpillar® track-type digging chains. Boom is furnished with grease actuated hydro-adjusters to maintain proper chain adjustment.

DIGGING CHAIN CARRIER ROLLERS

Top of boom is equipped with carrier rollers to reduce chain drag and assist chain in shedding excavated material.

FUEL CAPACITY

Dual tanks, 820 gallon (3100 L) total capacity, provide an 11-hour operating range at maximum power.

HYDRAULIC SYSTEM

Hydraulic system for propel, conveyor and cylinders includes oversize 345 gallon (1305 L) capacity reservoir with separate remote fan-driven oil cooler.

CONVEYOR SYSTEM

A straight, side-shiftable cross conveyor ejects material onto an elevatable extension conveyor. Both conveyors use 48" (1.22 m) wide belts and are hydrostatically driven allowing infinite speed adjustment and direction. The extension conveyor is adaptable to either side of the machine.

COUNTERWEIGHT

Hydraulically extendable counterweight is provided for increased stability when moving the machine with the boom raised.

CRAWLER

Extra heavy-duty Caterpillar® type components mounted on special heavy-duty long frames which are detachable for transport. Crawler rollers are oil-filled and sealed. Track adjuster is a Caterpillar® grease cylinder-type with double recoil springs.

CRAWLER DRIVE AND STEERING

Hydrostatic / Mechanical system consisting of a two speed hydraulic motor driving a planetary gearbox and a single stage roller chain. Crawl speed is infinitely adjustable from 0 to .75 mph (1.2 km/h). Tracks are independently, electronically controlled for speed, direction, and steering. Fail-safe brakes provided for parking and emergency use. The roller chains are fully enclosed and oil bath lubricated.

CUTTER BAR PLATES

Rectangular, high-alloy steel plates with Trencor® heavy-duty welded tooth holders. These plates accept conical carbide teeth for rock or the patented Trencor® spade teeth for dirt. Plates are sized according to the cut required and bolted to the digging chains.

TAILWHEELS

48" (1.22 m) diameter wheels with large bearings and heavy-duty seals.

WEAR PLATES

Boom equipped with replaceable, abrasive-resistant wear plates on top and bottom.

BOOM HOIST

Five, double-acting hydraulic cylinders provide boom hoist and positive down crowd. Three of the cylinders are mounted on top of the main-frame and the other two are mounted at the sides of the boom hood.

OPERATOR'S CAB

Fully enclosed with all machine controls within easy reach of operator. Elevates hydraulically 42" (1.07 m) for increased operator visibility. Cab heat and air conditioner is standard.

SAFETY SYSTEMS

A switch panel is provided on the side of the machine opposite the operator so an observer can either signal the operator or shut the machine down in an emergency situation. Any time there is a loss of hydraulic pressure in the traction system, the brakes automatically engage. All traction and digging chain controls must be in neutral before the engines can be started.

APPROXIMATE WEIGHT

400,000 - 450,000 lbs. (180,000 - 200,000 kg). Machine is designed and constructed with modular sections for ease of transport or shipment. No module exceeds 50 tons. Shipping weights of each module are available upon request.



Due to our continuing product improvement, specifications are subject to change without notice
Headquarters: 9600 Corporate Park Drive • Loudon, Tennessee 37774 USA •
USA Toll Free: 800-527-6020 • Tel: 865-408-2100 • Fax: 865-458-8575
Sales Office: 1400 E. Highway 26 • Grapevine, Texas 76051 USA •
Tel: 817-424-1968 • Fax: 817-421-9465
www.trencor.com

Copyright © 2001, Trencor, Inc. Form No. TSS-105-00 (WC1.5M) 08-03



CONSTRUCTION – CB PLANT



Batch Plant



Force line

CONSTRUCTION – CB WALL



Feb 9, 2022 9:31:49 AM
105 NW 20th St, Homestead, FL 33030, USA

CONSTRUCTION – CB WALL



Long reach excavator

CONSTRUCTION – SAMPLING



CB Wall sounding



CONSTRUCTION – WALL CAP



Jan 12, 2022 10:
18061 SW 152nd Ct, Miami, FL 33

Cap Excavation



Feb 15, 2022 9:38:33 AM
18081 SW 152nd Ct, Miami, FL 33187, USA

Cap backfill



Jan 12, 2022 11:34:23 AM
17150 SW 177th Ave, Miami, FL 33187, USA

Cap compaction

CONSTRUCTION – COMPLETED VIEW



New levee

Southern Segment



CONSTRUCTION – COMPLETED VIEW



Area completed



LPG2

ENP Wet

CONSTRUCTION – COMPLETED VIEW



CONSTRUCTION – COMPLETED VIEW



CONSTRUCTION – COMPLETED VIEW



LPG2



CONSTRUCTION – LESSONS LEARNED

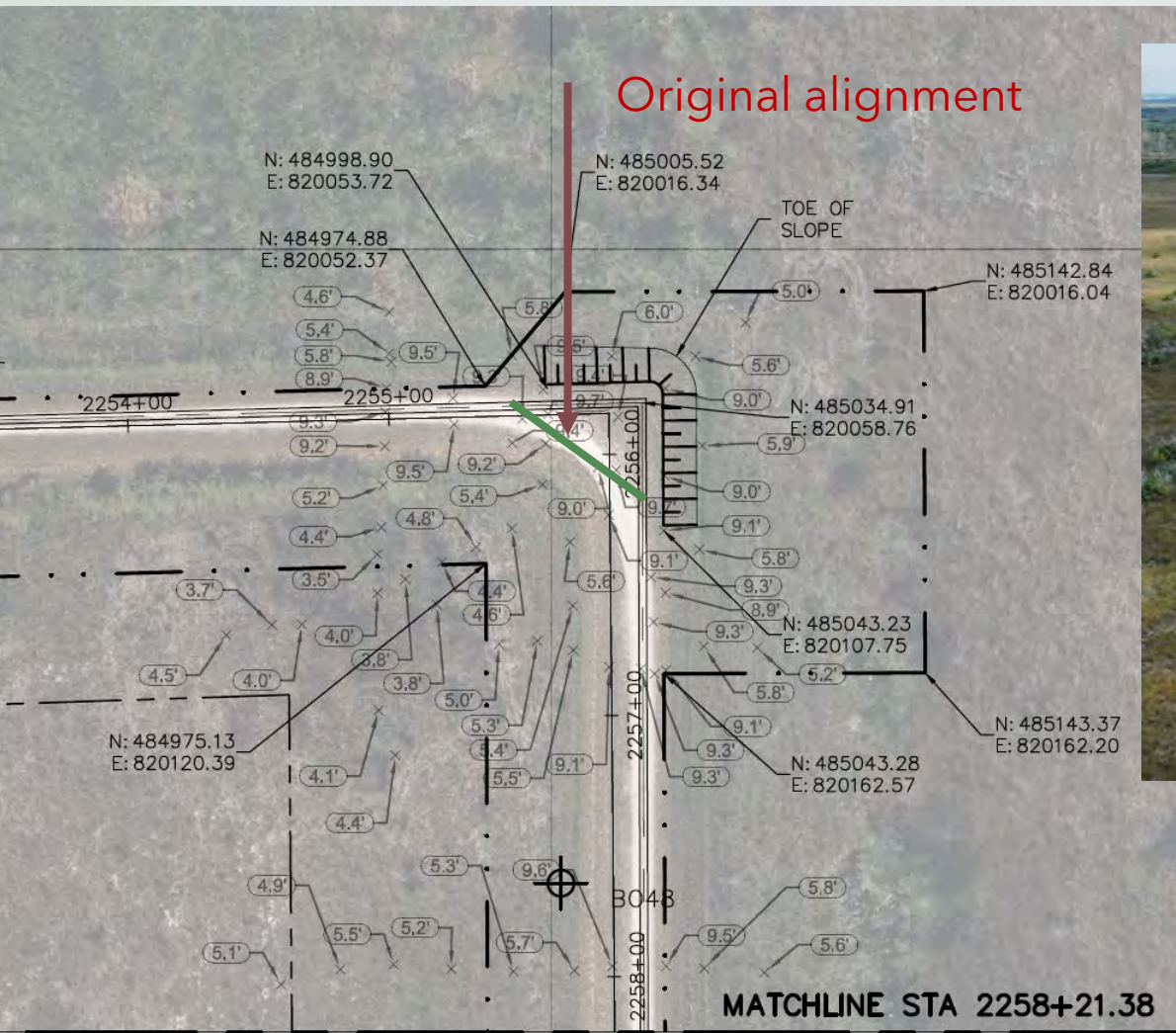

CONSTRUCTION – LESSONS LEARNED



Cracked levee



Grouted crack

CONSTRUCTION – LESSONS LEARNED



Grouted crack - slag-cement-bentonite mix



Verification boring,
phenolphthalein reagent

Questions and Answers



Thank you for attending our webinar today.

Would you like to attend our next webinar?

We have several webinars happening in the near future. Go to <https://www.aaees.org/events> to reserve your spot.

Would you like to watch this webinar again?

A recording of today's event will be emailed to all attendees.

Not an AAEEES member yet?

To determine which type of AAEEES membership is the best fit for you, please go to AAEEES.org or email Marisa Waterman at mwaterman@aaees.org.

Need a PDH Certificate?

You will be emailed a PDH Certificate for attending this webinar within the next week.

Questions?

Email Marisa Waterman at mwaterman@aaees.org with any questions you may have.

